

RCBS

2006 CATALOG



TABLE OF CONTENTS

Warranty	3
Presses	4 - 11
Case Prep	12-15
Case Trim	16-18
Priming	19-21
Scales	22-23
Powder Handling	24-28
The Grand Bushing Chart	29
Reference Chart	30
Reloading Dies	31-38
Special Order	39
Shell Holders	40
Extras	41
Bullet Casting	42-45
Reference	46
Promotional Items	47

The prices shown in this catalog are U.S. suggested retail only and are not necessarily the prevailing prices in your area. Export orders are subject to applicable import duties and/or sales tax, which are not reflected in the suggested retail price. Prices and specifications are subject to change without notice. Effective January 1, 2006.



A Message From RCBS' General Manager

Hunting is a tradition as old as recorded history. It is a recreation for enjoying nature and provides valuable lessons in individual responsibility and ethics. Hunting also brings us closer with our family and friends when we venture together into the great outdoors. Our favorite pastime helps us to build bonds, share values and build wonderful family traditions.

I have been blessed with many great hunting experiences over my life with family and good friends. But rarely have I found more enjoyment in life than I have in teaching my grandson the art of hunting and shooting. He is my newest hunting buddy no matter where we venture; deer hunting in the mountains, duck hunting in the valley or turkey hunting in the foothills. He is right there tagging along with me. It gives me tremendous pleasure to pass along my favorite hobby to my grandson and it serves our industry well in introducing new participants to the industry we all love.

Hunting may be a controversial subject in some circles, but I won't allow that to be the case in my circle of family and friends. As hunters we have the responsibility of insuring our own future. Next time you are at the shooting range or gun club take a look around and acknowledge the age of most participants. It is easy to see that if we are to insure a hunting and shooting heritage for future generations to come, we must individually and collectively encourage more young people to become involved in the sport that we love. This challenge lies squarely with you and me. Now is the time for all of us to take it upon ourselves and share our passion for shooting and hunting with the next generation. Together we can enjoy and benefit from this great heritage, while at the same time helping to preserve it for our grandchildren and generations beyond.

Allan Jernigan

General Manager, RCBS Operation

These warranties supersede all other warranties for RCBS products whether written or oral.

RCBS® LIFETIME WARRANTY

If any of your RCBS equipment breaks or doesn't work, we'll fix it or replace it (at RCBS' option). No time limit. RCBS does not provide a cash refund on any product. This warranty does not cover RCBS electronic powder handling products or any electrical products.

WARRANTY EXCLUSIONS: RCBS Reloading Equipment used in commercial situations, any failure or damage caused by unreasonable or abusive use and acts of nature (i.e. flood or fire).

RCBS® LIMITED WARRANTY

All RCBS Electronic Scales and Dispensers are covered by a limited 1-year warranty provided by the manufacturer. RCBS Electrical Products are guaranteed not to wear out or break from normal use for two years or they will be repaired or replaced (no cash refunds) at no charge if returned to the factory. All RCBS Electrical Products are intended for non-commercial use by hobbyists. Any other use of these products will void the RCBS Warranty.

WARRANTY EXCLUSIONS: RCBS Reloading Equipment used in commercial situations, any failure or damage caused by unreasonable or abusive use and acts of nature (i.e. flood or fire).

CUSTOMER SERVICE

Do you have any questions about how to use or operate an RCBS product? Looking for information about reloading? Need a replacement part for an RCBS product?

Don't hesitate to get in touch with the RCBS Technical Service Department. We are dedicated to giving the best service in the reloading industry. Our catalog is located on the web. Please contact us.

phone: 1.800.533.5000

fax: 530.533.1647

email: rcbs.tech@atk.com

www.rcbs.com

RCBS

605 Oro Dam Blvd.

Oroville, CA 95965

When requesting replacement parts, please give us the name of the product the replacement part is for, the part number (if known) and name of the replacement part. Replacement parts are usually shipped by the next working day via first class mail (large items by UPS Ground Service). Please be sure to give us your name, address and phone number. We'll only call if we have a question about your order.



P R E S S E S

The Mini Grand

The MINI GRAND seven station single stage shotshell press is optimum for use by hunters and target shooters. The MINI GRAND will load lead or steel shot (with optional conversion kit) and hulls up to 3 1/2". Loading rate is approximately 200 rounds an hour. The MINI GRAND utilizes the same powder and shot bushings as our popular THE GRAND progressive shotshell loader. Powder and shot bushing changes in about one minute. Powder capacity is one-half pound of your favorite smokeless powder. Shot capacity is 12 1/2 pounds.

The Mini Grand FEATURES & BENEFITS

- The frame is constructed of steel and a high grade aluminum base casting and features the famous RCBS Compound Leverage System
- Larger working window for greater visibility
- Independent wad guide system, wad can be placed in Wad Guide at any time in the operation
- Non-spring loaded handle
- Quick change RCBS or Hornady® powder and shot bushings
- Easy hull positioning with our unique shell holder design
- Six and eight point crimp starter included
- Seventh station for optional Taper Crimp die for reliable feeding in auto loading and pump shotguns
- Optional conversion kit for loading of steel shot
- One half pound smokeless powder capacity
- 12 1/2 pound shot capacity
- RCBS Lifetime Warranty



89014	MINI GRAND	12 Gauge	\$140.95
89015	MINI GRAND	20 Gauge	\$140.95
89016	MINI GRAND	12 Gauge Taper Crimp die	\$10.95
89017	MINI GRAND	20 Gauge Taper Crimp die	\$10.95
89018	MINI GRAND	Steel Shot conversion kit	\$12.95
86886	MINI GRAND	Dust Cover	\$20.95

Note: See page 29 for Shot & Powder Bushing information.

New!

The RCBS Handbook of Shotshell Reloading

The most up-to-date reference book on shotshell reloading and the only shotshell reloading manual exclusively featuring RCBS reloading presses. Destined to be the definitive handbook on shotshell reloading, this innovative work consists of 284 pages. The advanced shotshell reloader as well as the beginner will find this volume an invaluable guide with over 2000 reloading recipes, facts, brand new information, color photographs, cut-away and mechanical drawings, illustrations and a wealth of essential data not available anywhere else.

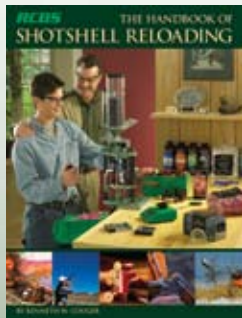

99903 RCBS Handbook of Shotshell Reloading \$21.95

The RCBS Handbook of Shotshell Reloading FEATURES & BENEFITS

- A full chapter on reloading safety
- Color identification photographs of both external and sectioned views of various hulls available today
- Color identification photographs of plastic wad columns
- Complete chapter of reference notes giving actual specifications for hulls shown in the section photographs – 56 separate reference notes
- Reference notes, I.D. photographs and reloading data are cross referenced by page number
- New information, and reloading data, for non-toxic shot-Steel, Bismuth and Hevi-Shot
- Complete chapter devoted to care, cleaning and fun with a shotgun
- Cost to reload chart
- Tear out Safety wall chart
- Reference section showing parts and drawings of RCBS Shotshell presses

The Grand

THE GRAND is intended for the shot gunner who requires accurate, precision shotshells for hunting or clay target shooting. The operator merely has to start a hull at station 1 and insert a wad in the wad guide at station 4. All other functions are performed automatically by THE GRAND. Once in full operation, a loaded shotshell is dispensed each time the handle is cycled through the full down and up strokes.

The case activated Powder System means no hull, no powder dropped and therefore no spillage, and there is no need to manually turn the powder on and off. Because the powder charging station is at the front of the press, it is easy to view the powder charge and convenient to remove the powder-charged hull for weighing the powder charge, if deemed necessary.

The Powder System provides three positions for the Powder Measure: "ON", "OFF", and "EMPTY". To completely empty the powder hopper, attach the drain tube and turn the powder measure to "EMPTY". The powder will then drop back into the powder can at the bottom of the drain tube. The Powder Bushings easily interchange in about 30 seconds. Powder Bushings are available for all popular loads. Hornady® Powder Bushings may also be used in THE GRAND charge bar.

The capacity of the Powder Hopper is 1 lb. of your favorite smokeless powder.

The Shot System is also case activated. Again, no hull, or no wad, no shot and best of all, no spillage. You never need to continually turn the shot measure "ON" or "OFF". The shot system is easily drained. Merely attach the drain tube below the shot measure. Shift the Shot Measure to "EMPTY". Shot then falls back in the shot bag or container. It's that quick and simple, plus no lead shot on the floor!



See your RCBS Dealer. Pull the handle and take a hull for a ride around the 8 stations to see how easy reloading shotshell ammo really is.

The Grand

FEATURES & BENEFITS

- The Massive Frame is constructed of high grade aluminum casting that's tied together with steel rods and links. The 1.5" diameter ram is joined to the famous RCBS Compound Leverage System for a smooth, solid, effortless feel. The large openings in the frame give easy access to all of the 8 stations.
- Universal Case Holders for easy removal or insertion of hulls at all stations. Allows sizing of the metal portion of the hull down to the rim.
- The Auto Indexing System is very simple, yet very reliable. It's easily removable for those who prefer manual indexing – pull the pin and the unit slips out in one piece!
- Steel Sizer Ring provides complete resizing of high and low base hulls – a feature not found on most other shotshell presses.
- The Tilt-Out Wad Guide is spring-loaded for easy, convenient feeding of wads. The Wad Guide is designed for use with Federal or your favorite brand of wads.
- Priming System feeds one primer at a time and is extremely reliable: no double – stacked primers, no overturned primers and no skipped primers.
- Powder System is no hull, no powder dropped and therefore no spillage. The powder system also provides three positions for the Powder Measure, "ON", "OFF", and "EMPTY".
- Shot System is case activated, which means no hull, or no wad, no shot and best of all, no spillage. The Shot Hopper has a capacity of 25 lbs. of shot.

Interchangeable Shot Bushings are changed in about 30 seconds, and are available for most popular charge weights and shot sizes.

Hornady® Shot Bushings are also compatible with THE GRAND charge bar.

The Shot Hopper has a capacity of 25 lbs. of shot.

Through the unique combination of the Powder System, Shot System and Universal Case Holders, the user can load just one hull at a time without the fear of spilling powder or shot.

Conversion Kits are available for changing to 12 gauge or 20 gauge as required. These make the changeover relatively easy and quick. Everything you need to make the changeover is included. U.S. Patent No. 6,772,668.

*Not for use with black powder. ⚠

89001	THE GRAND – 12 Gauge	\$812.95
89003	THE GRAND – 20 Gauge	\$812.95
89005	THE GRAND Conversion Kit – 20 Gauge	\$387.95
89007	THE GRAND Conversion Kit – 12 Gauge	\$387.95
89010	THE GRAND Riser Stand	\$24.95
86885	THE GRAND Dust Cover	\$21.95
89009	THE GRAND Hydraulic Unit	\$899.95*

*Direct from RCBS ONLY

Note: See page 29 for Shot & Powder Bushing information.

P R E S S E S

Pro 2000™ Progressive Press

The Pro 2000 is an easy to use five station manual indexing progressive press. Simply insert a cartridge case and bullet, cycle the handle and index the shell plate. The five station design allows for the use of a Powder Checker or Lock-Out die or you can seat bullets and crimp cases in separate operations. The APS priming system means that you never have to touch your primers. Primers can be inserted into the provided APS strips with the included Strip Loading tool or conveniently purchased already loaded with CCI® primers. Switching from large to small primer seating takes seconds. The quick change die plate allows you to leave dies set for quick caliber changeover and will accept any standard 7/8"-14 threaded dies. The Uniflow powder measure coupled with our Case Activated linkage system means powder charges will be dispensed accurately and only if a cartridge case is present! No more accidental powder spillage mishaps! The large working window and Universal Case Retention system allows easy removal and insertion of cases at any station. Compound leverage makes resizing rifle and pistol cases effortless. The rugged cast iron frame will provide a lifetime of service and the RCBS warranty guarantees it!

See page 40 for list of Shell Plates.

88875	Pro 2000 Progressive Press	\$587.95
88878	Pro 2000 Star Wheel	\$7.95
88876	Tube Priming Conversion Kit	\$113.95
88879	Low Primer Detector	\$33.95
86767	Dust Cover	\$16.95
09627	Pow'r Punch Decap Rod	\$6.95



Pro 2000™ Deluxe Reloading Kit

Contents: Pro 2000 Progressive Press with APS Priming System and Case Activated Powder Dispensing System with Uniflow Powder Measure. Trim Pro Manual Case Trimmer Kit, includes Trim Pro Shell Holders #2, 3, 4, and 10. Trim Pro Pilots #22, 24, 25, 27, 28, 30, 35, 44 and 45 calibers. Speer Reloading Manual. APS Strip Loader. Case Lube Kit includes: Case Lube Pad, 2-ounce bottle of Case Lube-2, Accessory Handle with Small and Medium Case Neck Brushes. Deburring Tool for .17 to .45 calibers.



Fold-up Hex Key Wrench with 8 popular sizes of wrenches. Stainless Steel Dial Caliper for checking case length, overall cartridge length, etc., capacity 0-6". RangeMaster 750 Electronic Scale, Strip Loader with 32 empty strips.

88880	Pro 2000 Deluxe Reloading Kit	\$1006.95
-------	-------------------------------	-----------

Pro 2000/Piggyback® -3 & -4 Die Plate

Make caliber changes quickly and easily. Leave the reloading dies set up. Eliminates the need to install and adjust dies for each reloading session.

88877	Pro 2000/PiggyBack -3 & -4 Die Plate	\$19.95
-------	--------------------------------------	---------

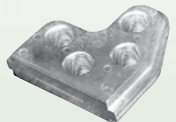

Pow'r Punch Decap Rod

For use with pistol calibers in Progressive Presses. The decap rod has a spring loaded decapping pin to insure the spent primer is always fully ejected from the primer pocket. Eliminates indexing problems with progressive presses caused by the spent primer jamming the shell plate. Works in all RCBS pistol sizer dies. RCBS pistol sizing dies equipped with the Pow'r Punch Decap Rod Assembly will work in any brand progressive press that uses standard 7/8"-14 threaded dies.

09627	Pow'r Punch Decap Rod	\$6.95
-------	-----------------------	--------



Piggyback™ - 3 & -4

If you own an RCBS Rock Chucker, Reloader Special-3, or Reloader Special-5, (each sold separately), you know they're some of the finest single-stage presses ever built. The Piggyback™-3 moves you from single-stage reloading to 5-station, manual indexing, progressive reloading in one step, and moves your output from 50 rounds an hour to well over 400.

If you own the new RC Supreme, the Piggyback™-4 is the unit to convert the press to progressive operation.

Optional extra Star Wheel can remain permanently attached to the Shell Plate for quicker caliber changeover. Piggyback™ -3 & -4 include strip loading tool with 32 empty strips.

87810	Piggyback - 3	\$360.95
87811	Piggyback - 4	\$360.95
88878	Pro2000/Piggyback - 3, -4	\$7.95
	Star Wheel	
86767	Dust Cover	\$16.95
09627	Pow'r Punch Decap Rod	\$6.95

The Piggyback™ -3 & -4 is an accessory item for your existing press. Requires Uniflow Powder Measure (not included) See page 40 for list of Shell Plates.

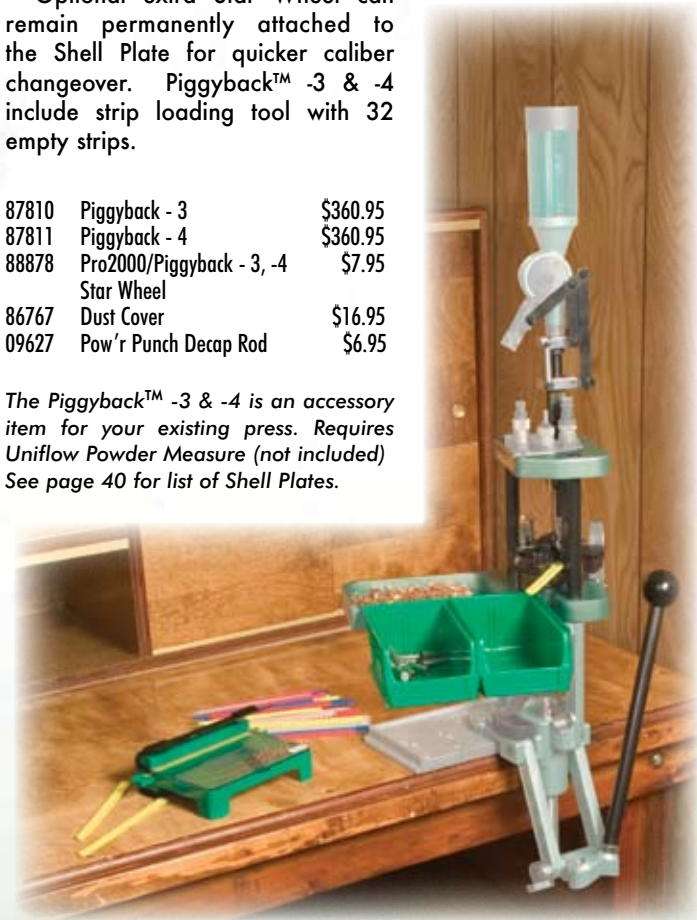

The RCBS Piggyback™ -3 & -4

FEATURES & BENEFITS

- Easy installation
- Fastest and simplest caliber conversion of any Progressive Press on the market
- Case activated powder measuring system is the most reliable powder dispensing method available (not for use w/black powder)
- Utilizes APS® Priming System, the most reliable, convenient and safest available
- APS Primer Strip Loader included
- Handles all 7/8"-14 dies
- Five stations allow use of lube die, lock-out die, powder checker, or separate crimp die
- Simple Universal Case Retention System allows easy removal and insertion of cases at each station
- Self-cleaning Shell Plate Holder
- Includes bullet tray, loaded cartridge box and empty case box
- Piggyback™ -3 reloads all pistol (except 25 Auto) and rifle calibers up to 223 Rem. (2.260" OAL)
- Piggyback™ -4 reloads all pistol (except 25 Auto) and rifle calibers up to 30-06 Sprg. (3.340" OAL)



Die Lock-Ring Wrench

No more bashed knuckles or fumbling with adjustable wrenches. The RCBS Die Lock-Ring Wrench simply slips onto the die lock ring for quick and easy adjustment. A pivoting handle allows leverage from any angle and the heat-treated steel stands up to all the brute force you can muster.

09634 Die Lock Ring Wrench (1-3/16") \$5.95

Powder Checker

A simple, effective way to visually check powder charges when you use a progressive press. The Powder Checker sits between the powder charging and bullet seating stations. Using a probe rod, it lets you visually confirm that the case is properly charged with powder before bullet seating. In addition to spotting a "no-charge" condition, the Powder Checker shows low and high charges too. Black oxide finish provides contrast for better visibility. For use with rifle and pistol cases.

87590 Powder Checker \$31.95



Lock-Out Die

The Lock-Out Die detects a "no powder" or a "double charge" condition in the progressive reloading process. It locks up, halting the travel of the ram, alerting the reloader to the problem so the cause can be corrected. Will not let you continue without removing the improperly charged cartridge. For use with straight-wall pistol calibers, 9mm and larger, and only on progressive reloading presses.

87540 Lock-Out Die \$48.95



P R E S S E S

RCBS Turret Press

Simple operation - no complex or automated processes. You have complete control over every reloading step. May be operated in progressive or single-stage mode.

In the progressive mode, output can be increased from 50 to 200 rounds per hour. Or, if preferred, the press can be used as a single-stage press and load cases in the batch mode.

Rugged, cast iron frame, toggle block and turret head. Heavy-duty construction to minimize springing. Detent on Turret Head for positive alignment. Standard 7/8"-14 threads for most popular reloading dies and accessories. Six-Station Turret Head allows many combinations in the mounting sequence of dies and powder measure permits two or more calibers to be set up at the same time. Turret Head held in place by one bolt for quick, easy changeovers. Turret Pin Assembly (provided for turret head removal and installation) and Ball Handle Assembly may be positioned for right or left-hand use. Standard Shell Holders slip into press ram and are securely held in place by a clip spring.

Primer Plugs and Sleeves are supplied for seating large and small primers. Primers are seated away from stacked primers. Safety tube included.

The Primer Catcher eliminates spent primers on floor - snaps off for easy emptying.

Baked epoxy finish for quick, easy cleaning, chip and fade resistant.

Note: We highly recommend the optional Uniflow Powder Measure with Case Activated Linkage Kit for use on the Turret Press. (Sold separately) See page 27.

88901 RCBS Turret Press \$231.95



Turret Deluxe Reloading Kit

With this kit you'll only need to add a Reloading Die Set and Shell Holder for the caliber(s) you intend to reload. Information on each individual kit component is described elsewhere in this catalog - see the index. Buy the kit and save about 10% of the price of each item separately.

Contents:

Turret Press
Uniflow Powder Measure
Model 5-0-2 Reloading Scale
Speer Manual #13
Case Lube Kit
Deburring Tool
Case Loading Block
Fold-up Hex Key Wrench Set
Primer Tray-2
Powder Funnel

88906 Turret Deluxe Reloading Kit \$447.95



RCBS Turret Head

Makes changing calibers quick and simple. Leave the dies set up in the Turret Head and change the Head - one bolt does the trick! Six stations with standard 7/8" - 14 threads.

88902 RCBS Turret Head \$48.95



AmmoMaster® .50 BMG Pack

The AmmoMaster .50 BMG Pack makes reloading for the .50 Browning Machine Gun cartridge a simple task. Manufactured to accept RCBS 1 1/2" .50 BMG dies, along with the massive 1" solid steel ram, provides more than enough strength to handle the .50 and will provide a lifetime of service. This kit includes the press, Full-Length sizer, Seater die, Shell Holder, Ram Priming Unit and Trim die in one convenient box. The only extras required are cartridge components and the rifle to fire them!

- 88700 AmmoMaster .50 BMG Pack \$635.95
- 88715 Standard Shell Holder Adaptor \$23.95



AmmoMaster®-2 Single Stage Press

The AmmoMaster-2 single stage press has been improved with the installation of the longer support columns and larger toggle block found on our AmmoMaster .50 BMG press. While still set up to use standard 7/8"-14 thread dies and standard shell holders to load most any pistol or rifle caliber, the addition of the .50 BMG 1 1/2" Die Kit(88705) will allow you to load from .25 ACP to .50 BMG.

For original AmmoMaster owners wishing to load .50 BMG, two kits are necessary. The .50 BMG 1 1/2" Press Conversion Kit and the .50 BMG 1 1/2" Die Kit. The Press Conversion kits contains the larger toggle block and support columns and the Die Kit contains a Full Length Size Die, Roll Crimp Seat Die, Trim Die, .50 BMG Shell Holder and .50 BMG Ram Priming Unit.

- 88703 AmmoMaster-2 Single Stage Press \$265.95
- 88705 .50 BMG 1 1/2" Die Kit \$397.95
- 88709 .50 BMG 1 1/2" Press Conversion Kit \$128.95
(for 88701 AmmoMaster)
- 88772 .50 BMG Ram Priming Unit \$44.95
- 88746 .50 BMG Shell Holder \$21.95
- 30065 .50 BMG Trim Die \$146.95
- 86767 Dust Cover \$16.95



AmmoMaster®/Piggyback® II Die Plate

Reduce the time and effort to remove, replace and adjust dies when making caliber changes on your AmmoMaster Auto or PiggyBack II conversion unit. This replacement top plate allows you to have additional calibers set up and ready. It is complete with five station top plate, clutch bearing with bushing, cam wire clip with lock nut and setscrew.

- 88799 AmmoMaster/PiggyBack II Die Plate \$31.95



Take a look at why the Rock Chucker® Supreme is the world's best selling press!

- Heavy-duty cast iron construction for easy case-resizing
- 1-inch ram held in place by 12.5 sq. inch of ram bearing surface
- Ambidextrous toggle block of ductile iron
- Compound leverage system
- Pins ground from hardened steel
- 1-1/4"-12 thread for Piggyback-4
- 7/8"-14 thread adapter for standard dies and accessories
- Window opening 4.25" to accommodate large magnum cartridges

Rock Chucker® Supreme Press

The most popular reloading press just got better! The Rock Chucker Supreme press has been lengthened to allow easy loading of today's longer cartridge designs and renamed the Rock Chucker Supreme. With the same easy operation, ambidextrous handle, outstanding strength and versatility, the Rock Chucker Supreme is ideal for the beginner and pro alike. It can also be upgraded to a progressive loader with the addition of a Piggyback-4.

09356	Rock Chucker Supreme Press	\$159.95
09552	Primer Plug, Sleeve & Spring (Lg.)	\$3.95
09553	Primer Plug, Sleeve & Spring (Sm.)	\$3.95
86881	Dust Cover	\$9.95

Rock Chucker® Supreme Master Reloading Kit (pictured above)

We've taken the new benchmark of single stage presses and surrounded it with the equipment you need (except dies and shell holders) to start loading like a pro. A simple solution for the beginner and pro alike, it is easily upgraded to progressive operation with the optional Piggyback-4. The Rock Chucker Supreme Master Reloading Kit includes: Rock Chucker Supreme Press, 5-0-5 Scale, Uniflow Powder Measure, Speer® Reloading Manual #13, Hand Priming Tool, Hex Key Set, Case Loading Block, Case Lube Kit, Powder Funnel and Deburring Tool.

09357	Rock Chucker Supreme Master Kit	\$369.95
-------	---------------------------------	----------

Equipment readily secures to plate for quick tool change-overs. Makes the most of limited bench space

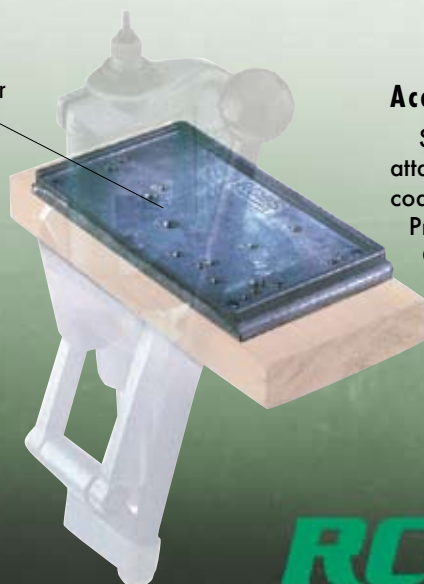

Accessory Base Plate-2

Save time, space and eliminate a loading bench top full of holes. Simply attach the Base Plate-2 to any work surface, then use the pre-tapped, letter-coded holes to quickly mount or dismount RCBS Case Trimmers, Trim Pro, Powder Measure Stand, Lube-A-Matic-2, Reloader Special, Rock Chucker, Pro 2000, Turret Press, AmmoMaster, Rock Chucker Supreme, Ammo Master-2, The Grand, Mini Grand, Partner Press and the APS Bench Mounted, Automatic and Standard Priming Tools. Fastening hardware included. Measures approximately 10" x 6" x 1".

09280	Accessory Base Plate-2	\$30.95
-------	------------------------	---------



Partner™ Press

Just starting out? The Partner Press is easy to use and incredibly durable. Our least expensive press offers big performance in a compact package. It's also perfect as a second press for different operations or a portable press for use at the range.

87460 Partner Press \$73.95
86881 Dust Cover \$9.95

Partner™ Press Reloading Kit

Our Partner Press anchors this excellent starter kit. Big on performance, small on price, the Partner is the ideal entry-level press. Here it's coupled with some of the finest "basic" reloading tools you'll find anywhere. The RCBS Partner Press Reloading Kit includes: Partner Press, RC-130 Scale, Case Loading Block, Case Lube Pad, Case Lube-2, Case Neck Brushes, Primer Tray-2, Deburring Tool, Powder Funnel and Speer Reloading Manual #13.

87466 Partner Press Reloading Kit \$187.95



Reloading Starter Kit

This is one of the truly remarkable values in reloading. It has everything you need to get started reloading rifle and pistol cartridges (except dies and shellholders), and is easily upgraded to progressive operation with the optional Piggyback-3. For "upscale" reloading at an affordable price, this kit can't be beat. The RCBS Reloading Starter Kit includes: Reloader Special-5 Press, 5-0-5 Scale, Case Loading Block, Case Lube Kit, Primer Tray-2, Powder Funnel, Deburring Tool and Speer Reloading Manual #13.

09045 Reloading Starter Kit \$298.95

Reloader Special-5™ Press

The latest in our popular line of Reloader Special presses. Featuring a more comfortable ball handle and a primer arm that lets you prime cases at the same time you resize.

09285 Reloader Special-5 Press \$130.95
86881 Dust Cover \$9.95

RCBS

CaseMaster™ Gauging Tool

A quick, convenient way to determine several important case and cartridge dimensions. The CaseMaster gauging tool measures case neck concentricity, uniformity and thickness, as well as case length and bullet run-out. All are important to accuracy and safety. Detects case head separation before symptoms are apparent on the outside of case. Much quicker than a dial caliper and makes a tedious job simple and less tiring.

87310 CaseMaster Gauging Tool \$109.95

Dial indicator accurately displays various measurements to .001" for the discriminating handloader who demands a higher level of ammunition performance

Has the ability to measure case neck thickness

Fully-adjustable V Blocks to securely position the case for accurate measure

Compact base for convenience yet steady enough to support the tasks required

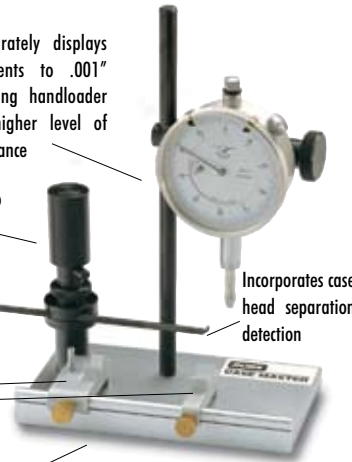

Electronic Digital Caliper

Instant reading. Very easy to use. Hardened stainless steel body for prolonged tool life. Switches from inches to millimeters with the touch of a button. Range of 0-6"/0-150mm. Accuracy +/- 0.001"/0.02mm. Resolution: 0.0005"/0.01mm. Large, easy to read numbers, reduces error - no guessing. Adjusts to zero at any position. Measures internal, external, depth and step dimensions. Jaw depth measures about 1-1/2" outside, 5/8" inside. Lock holds slide in position for measuring constants. Battery included. Fitted plastic storage case. Imported.

87323 Electronic Digital Caliper \$62.95

Dial Caliper/Case Length Gauge

Fiberglass reinforced super polyimid construction. Range of 0-6"/0-150mm. Direct .001" readings. Graduations .001" increments with 0.100" per single revolution of dial; 1.0mm bar scale. Dial adjustable to zero. Four-way measurements: outside, inside, depth and step. Comfortable friction thumb roller opens and closes caliper. Large, easy to read black numbers and markings on white background. Fitted clear plastic storage case. Imported.

87301 Dial Caliper/Case Length Gauge \$50.95



Stainless Steel Dial Caliper

Hardened stainless steel construction. Matte, non-glare finish. Range 0-6". 0.100" direct reading per revolution. 0.001" graduations. Accurate to +/- 0.001". Four-way measurement capability: inside, outside, depth and step. Shockproof movement for accurate measurements. Clear glass lens protects dial from dust and scratches. Slide may be locked in any position with thumb lock. Dial easily zeroed. Lock screw holds dial in position for precise measurements. Thumb wheel makes for easy opening and closing of the caliper. Fitted hard plastic storage case. Imported.

87305 Stainless Steel Dial Caliper \$40.95



Vernier Ball Micrometer

Economical Vernier Ball Micrometer for measuring case neck thicknesses. All metal body and thimble with matte finish. Range: 0-1", Accuracy to .0001". Ratchet stop on thimble assures uniform application of pressure. Thimble lock keeps thimble from turning when measuring a constant. Adjustment wrench included. Fitted plastic storage case. Imported. (Not shown)

87324 Vernier Ball Micrometer \$49.95

Mechanical Digital Micrometer

Quick, easy to read. Enamelled metal body with satin chrome thimble. White numbers on black background. Outside micrometer has 0-1" range. Mechanical counter reads to .001". Resolution: .0001". Accuracy: .0001". Ratchet stop on thimble applies even pressure for measuring. Thimble lock stops thimble from turning when measuring like objects. Adjustment wrench included with fitted wooden storage case. Imported.

87322 Mechanical Digital Micrometer \$50.95



Electronic Digital Micrometer

Instant reading. Top of the line. Enamelled metal body with matte finished, non-glare thimble. Outside micrometer has 0 to 1"/0 to 25mm range. Counter reads to 0.00005". Resolution 0.0005"/0.001mm. Accuracy 0.00005"/0.001mm. Large, easy to read numbers for error reduction with instant inch/millimeter conversion. Zero adjust at any position. Thimble lock for measuring like objects. Battery included. Auto off after 5 minutes for longer battery life. Fitted wooden storage cases. Imported.

87320 Electronic Digital Micrometer \$116.95



Vernier Micrometer

Economical version without the bells and whistles. All metal body and thimble with silver matte finish. Crisp black numbers and markings for easy reading. Range: 0-1". Reads to .0001 of an inch. Accuracy within .0001". Ratchet stop on thimble assures uniform application of pressure when measuring. Thimble lock keeps thimble from turning when measuring a constant. Adjustment wrench included. Fitted plastic storage case. Imported.

87321 Vernier Micrometer \$29.95



Precision Mic™

A few twists of the Precision Mic and you'll know your chamber headspace and bullet seating depth to 0.001 of an inch. Precision Mic measures from the datum point on the case shoulder to the base, giving you spot-on ANSI/SAAMI tolerance readings. An indispensable tool for safe, accurate loads that extend the life of your brass and rifle.



Precision Mic Sizes: \$51.95

88299	.204 Ruger	88308	.257 Robts.	New 88330	.325 WSM	88328	300 RUM
88302	.22-250	88314	6.5mm x 55	88331	.338 Win. Mag	88333	338 RUM
88301	.220 Swift	88316	.270 Win.	88337	.375 H&H Mag	88339	375 RUM
88303	.222 Rem.	88317	.280 Rem.	88315	270 WSM	88321	7MM RSAUM
88304	.223 Rem.	88319	7mm Rem Mag	88318	7MM WSM	88326	300 RSAUM
88300	.223 WSSM	88322	7mm-08 Rem.	88325	300 WSM		
88305	.243 Win.	88323	7mm x 57 Msr	88340	7mm RUM		
88309	.243 WSSM	88324	.30-06 Spgfld				
88306	6mm Rem.	88327	.300 Win. Mag				
88310	.25 WSSM	88329	.308 Win.				
88307	.25-06						

Case Slick® Spray Lube

Case Slick is an exclusive formulation that provides exceptional lubricity for resizing or forming of metallic rifle and pistol cases. Testing reveals, Case Slick reduces the force needed to resize 308 Winchester cases by 35 to 70 percent when compared to other spray lubes. Reducing the resizing force makes the process easier on you and your brass. Case Slick is formulated to flow evenly over the surface of the brass. Uniform coverage makes resizing a breeze and eliminates the possibility of denting the shoulder of the case.

09315 Case Slick Spray Lubet† \$6.95



† Shipped UPS Ground only. No international sales

Case Lube Kit

Properly clean and lube cases for resizing the simple way with this complete kit. Includes Case Lube Pad, 2-ounce bottle of Case Lube-2, and Accessory Handle with two interchangeable Case Neck Brushes for .22 thru .30 calibers.

09335 Case Lube Kit \$20.95



Case Lube-2 (Pictured above with Case Lube Kit)

An excellent lubricant that's water soluble and convenient to wipe off easily with no sticky residue. Non-toxic. Use Case Lube-2 with RCBS Lube Dies or Case Lube Pad.

09311 Case Lube-2 (2 oz. bottle) \$3.95
09313 Case Lube-2 (gallon/bulk) \$131.95

Case Neck Brushes (Pictured above with Case Lube Kit)

Clean dirt and powder residue from inside necks and simultaneously lubricate for expansion with our case neck brushes. The no-roll handle design accepts all three nylon bristle brushes: small brush for .22 to .25 caliber, medium brush for .270 to .30 caliber, large brush for .35 to .45 caliber.

Case Neck Brushes: \$2.95
09327 Small
09328 Medium
09329 Large

Lube Dies

Decap and lube cases in one step with our exclusive Lube Die. Designed for progressive presses like the Pro 2000, Piggyback-3, Piggyback II, AmmoMaster, and Auto 4x4, but works just fine in single-stage presses. Four sizes cover 45 popular calibers. It's faster and cleaner than a lube pad; easy to refill with lubricant (RCBS Case Lube-2); standard 7/8"-14 thread.

Lube Dies \$36.95

87551 Number 1
87552 Number 2
87553 Number 3
87554 Number 4
87575 Decap Unit



See Reference Chart on page 30

Decap Die

Use our Decapping Die to quickly remove primers from cases prior to cleaning. A single die handles calibers from .22 through .45. Plastic storage box is included.

The HD unit is designed for use on military crimped cases.



87580 Decap Die \$16.95
87585 H.D. Decap Die 27-45 Cal \$16.95
87575 Decap Unit 22-45 Ca \$7.95
87586 H.D. Decap Unit \$7.95

Military/Berdan Decapping Tool

For efficient removal of Berdan primers, nothing beats our Berdan Decapping Tool. Decap 8mm Rimless, 6.5mm Mannlicher-Schoenauer, 11.7mm Rimmed and more. All functional parts are made of top-grade, heat-treated steel alloy for toughness. Comes with case holder and hex wrench.

09525 Berdan Decapping Tool \$56.95
09528 Berdan Decapping Pin \$4.95



Case Lube Pad (Pictured above left with Case Lube Kit)

The best way to lubricate cases for resizing or forming. Coat the pad with Case Lube-2, then roll the case lightly across it. Exactly the right amount of lubricant is transferred to the case. Pad is removable from sealable storage case for easy cleaning.

09307 Case Lube Pad \$9.95

RCBS



Primer Pocket Brush Combo

A build-up of residue in primer pockets can cause misfires. A couple of twists with our Primer Pocket Brush and residue is easily cleaned out. Brushes have stainless bristles and interchangeable mounts for large and small primer pockets. Comes with a no-roll accessory handle.

09574	Primer Pocket Brush Combo	\$15.95
09578	Small Brush only	\$6.95
09577	Large Brush only	\$6.95
09330	Handle	\$4.95

Flash Hole Deburring Tool

Burrs left on the inside of the flash hole during manufacturing can cause erratic ignition. This handy tool automatically locates the hole and quickly removes the burr. A self-centering pilot collar with an adjustable stop allows quick alignment and prevents the removal of too much brass.

Flash Hole Deburring Tools with Case Pilot Stops: \$12.95

88102	.22 Cal.	88107	7mm Cal.
88103	6mm Cal.	88108	.30 Cal.

Flash Hole Case Pilot Stops only: \$4.95

88122	.22 Cal.	88131	.34 Cal.
88123	6mm Cal.	88133	.35 Cal.
88124	.25 Cal.	88134	.36 Cal.
88125	6.5mm Cal.	88135	.375 Cal.
88126	.270 Cal.	88136	40/10mm
88127	7mm Cal.	88137	.41 Cal.
88128	.30 Cal.	88138	.44 Cal.
88129	.32 Cal.	88139	.45 Cal.
88130	8mm Cal.		

88144 Replacement Rod & Cutter Assembly \$9.95

Standard Bullet Puller Collets:		\$11.95	
09419	.17	09430	.35/.38Spec.
09438	.20	09437	9.3mm
09420	.22	09431	.375
09421	6mm	09432	.40
09422	.25	09433	.41
09423	6.5mm	09434	.416
09424	.270	09435	.44/11mm
09425	7mm	09436	.45
09426	.30/7.35	09439	.475
09427	.338	09445	.500
09428	.32/8mm		
09429	.348		



Primer Pocket Swager Combo

The perfect tool for quick removal of primer-pocket crimps from military cases. Unlike reaming, the pocket swager forms a perfectly round pocket correct in dimension for American Boxer-type primers. Comes with swaging heads for large and small pockets; fits nearly all 7/8"-14 presses with RCBS-type removable shell holders. Not for use on progressive presses.

09495 Primer Pocket Swager Combo \$31.95

Pow'r Pull™ Bullet Puller

This indestructible tool is the easy way to fix mistakes. An improved 3-jaw chuck firmly grips the case rim; just rap it on a solid surface like a hammer. Powder and bullet drop into the main chamber for re-use. A soft cushion prevents any damage to bullet. A solid one-piece body adds extra strength and a generous handle size adds user comfort. Of course, it's guaranteed for life. Works with most centerfire cartridges from .22 to .45.

09415	Pow'r Pull Bullet Puller	\$16.95
09418	Replacement Chuck Assembly	\$5.95
09416	Magnum Chuck Assembly (for WSM & Belted Mags)	\$5.95

Not for use with rimfire cartridges. ⚠️



An inexpensive reloading "eraser" that takes the hassle out of dealing with those occasional undesirable loads

Large handle size for fuller-fitting/sure gripping use

Standard Bullet Puller

Not sure about the powder charge? Need to change bullets? The RCBS Bullet Puller is designed to easily pull and not damage jacketed bullets. It utilizes the standard 7/8"-14 thread and may be used in any single stage reloading press having this thread.

09440 Standard Bullet Puller w/o Collet \$20.95

Not for use with rimfire cartridges. ⚠️



Deburring Tool

Prep cases fast, insert the pointed end to remove burrs and bevel inside the case. Fit the open end over the case mouth to remove exterior burrs. Hardened cutting flutes stay sharp for years. Knurled for hand or lathe use. Cases from 17 to 45.

09349 Deburring Tool \$16.95



Deburring Tool .17-.60

This larger Deburring Tool allows the inside and outside chamfering and deburring of cases from .17 caliber up to .60 caliber. Larger than our standard deburring tool, this may not be the one for you especially if you do not handload cases over .45 caliber. But if you want one deburring tool to do it all, this is it! Made of hardened tool steel to last a lifetime.

09348 Deburring Tool .17-.60 \$18.95

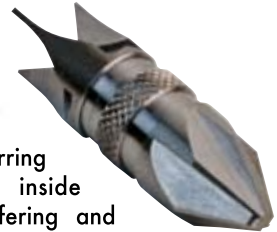

VLD Deburring Tool

The increasing popularity of VLD style bullets has lead RCBS to offer a 22 degree VLD Debur tool. The 22 degree angle allows the bullet to be seated into the case without damaging the boattail and ruining accuracy. The VLD debur tool can be used as is, attached to a RCBS Accessory Handle or mounted on the Trim Mate Case Prep Center.

9350	VLD Deburring Tool w/Handle	\$13.95
9351	VLD Debur Tool	\$9.95





Vibratory Case Cleaner

Fast, dry-media case cleaning. Holds up to 400 .38 Special or 180 .30-06 cases. Removable lid lets you check cases during cleaning. The optional Media Sifter separates clean cases from dry media in seconds. Quiet, powerful motor is thermally protected and 1/4" thick bowl will last you a lifetime.

Not for use with liquid media.

Vibratory Case Cleaner:		
87088	120 VAC	\$78.95
87090	240 VAC-EUR	\$78.95

Case Cleaning Media

Our Liquid Cleaner (Sidewinder only) gets the dirtiest cases spotless in minutes. It's concentrated too: an 8 oz. bottle makes about 4 gallons. Our dry media can be used in both Sidewinder and Vibratory Case Cleaners. Formula 1 Walnut Shell is ground to a 12/12 sieve size. Formula 2 is Corn Cob. Polish comes individually packed so you can choose various amounts of media to mix.



87067	Formula 1 Walnut Shell Dry Media	\$15.95
87068	Formula 2 Corn Cob Dry Media	\$16.95
87069	Polishing Compound (5-Pack)	\$5.95
87015	Liquid Case Cleaner (Sidewinder Only)	\$6.95

Rotary Case/ Media Separator

In short order, separate the cleaned cases from the cleaning media. Merely empty the cases and media from the case cleaner into the separator basket. With several turns of the basket handle the media falls to the bottom of the separator, leaving the cases clean and ready to use. The fine dust from the media is trapped inside the separator. Heavy-duty plastic construction for years of trouble-free service. Capacity: about 180 .30-06 cases or 400 .38 Special cases with media.

87076	Rotary Case/Media Separator	\$36.95
-------	-----------------------------	---------

Sidewinder™ Case Tumbler

Sidewinder Case Tumbler gives brass cases a thorough cleaning, inside and out. It comfortably can clean up to 300 .38 Special cases or 150 .30-06 cases at a time with either wet or dry media. Its quiet motor is connected to a timer switch for automatic cut-off. Drums come with an extra perforated lid that quickly separates liquid or dry cleaning media from cleaned cases. An eight-ounce bottle of concentrated Liquid Case Cleaner is included. Extra drums are also available and are great for Moly coat application of bullets.

Sidewinder Case Tumbler:		
87000	120 VAC	\$325.95
87005	240 VAC-EUR	\$346.95
87050	Drum Assembly	\$87.95



New!

Universal Case Loading Block

The new RCBS® Universal Case Loading Block has been designed to fit most any standard rifle or pistol case including the WSM, WSSM and Ultra Mag family of cartridges. The two-sided design offers three different case fits per side and will hold 50 cases. Short pistol cases fit in the raised upper portion of the block for easy access. The stepped holes accommodate large pistol and rifle cases.

09452	Universal Case Loading Block (50 cases, multiple fit)	\$7.95
-------	---	--------

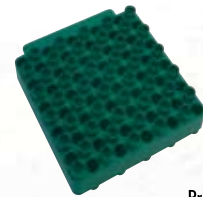

Prototype shown

Case Loading Block

A solid, steady platform that holds 40 cases at a time to streamline powder charging and inspection. Stepped holes minimize case tipping to reduce powder spillage. For most rifle and pistol cases. Approx. 4-7/8 x 7-1/4".

09453	Case Loading Block	\$6.95
-------	--------------------	--------

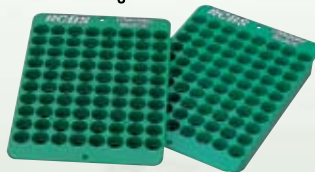

Case Cleaner Media Sifter

Quickly and easily separate the cleaning media from the cleaned cases. First dump the cleaned cases and media into a bucket. Next attach the Media Sifter to the Vibratory Case Cleaner and turn on the cleaner. Slowly pour the cases and media into the media sifter. Allow the Case Cleaner to run until all the media is emptied back into the bowl - ready for the next time cases need cleaning.

87075	Case Cleaner Media Sifter	\$12.95
-------	---------------------------	---------



C A S E T R I M



Trim Pro® Manual Case Trimmer Kit

Case trimming is no longer a drudgery. Trim cases simply with a few turns of the handle. The Trim Pro's spring-loaded lever shell holder eliminates the muscle fatigue associated with long hours of tightening a T-bar. The Shell Holder keeps cases securely locked in place and aligned with the cutter. It is designed for .001" accuracy even with a spent primer in the case. Works with standard pilots and features a micrometer fine-adjustment bushing calibrated for setting exact trim length. Made of die cast metal with hardened cutting blades for a lifetime of reliable use. Includes: Shell Holders 2, 3, 4 and 10. Pilot calibers: .22, .24, .25, .27, .28, .30, .35, .44 and .45.*

90355	Trim Pro Manual Case Trimmer Kit	\$105.95
90357	Trim Pro Manual Case Trimmer (w/out Shell Holders or Pilots)	\$86.95
86883	Dust Cover	\$9.95
98930	Power Drill Converter	\$6.95

*Additional shell holders/pilots see page 17

TRIM MATE CASE PREP CENTER AND ACCESSORIES:

90375	Trim Mate Center 110 VAC	\$133.95
90376	Trim Mate Center 240 VAC-EUR	\$152.95
90377	Dry Case Neck Lube	\$2.95
90378	Primer Pocket Uniformer, large rifle	\$23.95
90383	Primer Pocket Uniformer, large pistol	\$23.95
90379	Primer Pocket Uniformer, small	\$23.95
90380	Military Crimp Remover, large	\$17.95
90381	Military Crimp Remover, small	\$17.95
90382	Dust Cover	\$11.95
09351	VLD Deburring Tool	\$9.95

For Flash Hole Deburring Tool see page 14

The Trim Mate Case Prep Center

FEATURES & BENEFITS

- Works great with Trim Pro Power Case Trimmer
- Speeds up case prep while you trim
- Tough, high-torque motor
- Includes primer pocket brushes, chamfering and deburring tools, case neck brushes and a packet of dry case neck lube



The Trim Pro Power Case Trimmer is better than having a personal lathe for case trimming.

Trim Pro® Power Case Trimmer Kit

You'll actually look forward to case trimming. A low RPM motor delivers plenty of torque. The spring-fed cutter is easy and accurate. No pushing or feeding pressure is needed, leaving your hands free for deburring or other tasks. A positive locking handle and integral power switch makes it simple and safe. Includes: Shell holders 2, 3, 4 and 10. Pilot calibers: .22, .24, .25, .27, .28, .30, .35, .44 & .45.*

90350	Trim Pro Power Case Trimmer Kit 110 VAC	\$288.95
90351	Trim Pro Power Case Trimmer Kit 240 VAC -EUR	\$296.95
90359	Power Unit Only 110 VAC	\$226.95
90364	Power Unit only 240 VAC	\$235.95
86882	Dust Cover	\$11.95
09406	Case Trimmer Cutter	\$15.95



Replacement Case Trimmer Cutter used with all Trim Pro and Rotary Case Trimmers

The most popular Trim Pro Shell Holders and pilots are included with the kits or can be purchased separately.

Trim Mate™ Case Prep Center

Case preparation just became five times easier and faster with the Trim Mate Case Prep Center. Five gear-driven rotating heads turn the tedious task of chamfering, deburring, primer pocket cleaning, military crimp removal and flash hole deburring into child's play. The tough, high-torque motor does all the work, allowing you quick case movement from station to station. Works great with the Trim Pro Power Case Trimmer so you can do case prep and trimming at the same time. There are also two stationary positions for case neck brushes or other useful accessories, and a cupped area for securing dry case neck lube. The Trim Mate Case Prep Center includes large and small primer pocket brushes, inside chamfering and outside deburring tools, medium and small case neck brushes and a packet of dry case neck lube. There are also a number of optional accessories available.

Primer Pocket Uniformers are manufactured with high speed tool steel cutters and true the primer pocket wall and bottom. Military Crimp Removers are made with hardened steel cutters and ream out the crimp ring found in military cases.



Case Trimmer Pilots

Designed with a taper to guide pilot into the case mouth. Prevents case from wobbling when trimming case to length. Refer to the reference chart on page 30 to determine the correct pilot for a specific caliber. For use with RCBS Trim Pro® Case Trimmers, Rotary Case Trimmer-2 and Rotary Case Trimmer.

For use with RCBS Case Trimmers only
(See chart below)



Case Trimmer Pilots \$4.95

.17 Cal.	09377
.20 Cal.	09376
.22 Cal.	09378
.24 Cal.	09379
.25 Cal.	09380
.26 Cal.	09381
.27 Cal.	09382
.28 Cal.	09383
.30 Cal.	09384
.31 Cal.	09385
.32 Cal.	09386
.33 Cal.	09387
.34 Cal.	09388
.35 Cal.	09389
.36 Cal.	09390
.37 Cal.	09391
.40 Cal.	09392
.41 Cal.	09393
.416 Cal.	09397
.44 Cal.	09394
.45 Cal.	09395
.45-R Cal.	09396
.475 Cal.	09398
.500 Cal.	09399

Trim Pro Pistol Pack 90361 \$20.95
CT Pilot, 40 Caliber
CT Shell Holder #6
CT Shell Holder #16
CT Shell Holder #18
CT Shell Holder #27
Trim Pro Rifle Pack 90362 \$19.95
CT Shell Holder #2
CT Shell Holder #3
CT Shell Holder #4
CT Shell Holder #10
Trim Pro Pilot & Shell Holder Pack 90363 \$41.95
CT Pilot 22 Cal.
CT Pilot 24 Cal.
CT Pilot 25 Cal.
CT Pilot 27 Cal.
CT Pilot 28 Cal.
CT Pilot 30 Cal.
CT Pilot 35 Cal.
CT Pilot 44 Cal.
CT Pilot 45 Cal.
CT Shell Holder #2
CT Shell Holder #3
CT Shell Holder #4
CT Shell Holder #10

See the Reference Chart on page 30 to determine the Trim Pro Shell Holder number required



Trim Pro® Case Trimmer Stand

Raise your manual case trimmer to new heights with the Trim Pro Stand. Provides more working room and hand clearance. Also provides convenient storage space for Trim Pro Shell Holders and Pilots. Stand mounts easily on accessory base plate or directly on a bench. Dimensions: 4 - 7/8" x 8 - 5/8" x 1". Manual trimmers only.

Shell Holders and Pilots sold separately

90360 Trim Pro Case Trimmer Stand \$20.95

Trim Pro® 3-Way Cutter

This is automated case preparation at its finest. Our 3-Way Cutter is one of those accessories you can't live without. Its unique three-blade head configuration trims cases like our standard cutting tool, but in addition to trimming to length, inside blades chamfer the case while an outside blade deburrs it. The three-way cutter attaches easily to both Case Trimmers and Trim Pros.

Trim Pro 3-Way Cutters:
(includes cutter & pilot) \$53.95

90276	.17 Cal.	90282	.270 Cal.
90277	.20 Cal.	90283	7mm Cal.
90278	.22 Cal.	90284	.30 Cal.
90279	6mm Cal.	90285	.32 Cal.
90280	.25 Cal.	90287	.338 Cal.
90281	6.5mm Cal.	90291	.375 Cal.

Trim Pro 3-Way Pilot/Chamfer \$8.95

90256	.17 Cal.	90262	.270 Cal.
90257	.20 Cal.	90263	7mm Cal.
90258	.22 Cal.	90264	.30 Cal.
90259	6mm Cal.	90265	.32 Cal.
90260	.25 Cal.	90267	.338 Cal.
90261	6.5mm Cal.	90271	.375 Cal.



Trim Pro Case Holder Accessory

Upgrade your Rotary Case Trimmer-2 simply by adding this lever-handle shell holder system. Makes case trimming faster and easier than using the old draw collet system. It's also more accurate because the case is perfectly aligned. Uses Trim Pro Shell Holders.

Not for use with with Rotary Case Trimmer

90358 Trim Pro Case Holder Accessory \$44.95

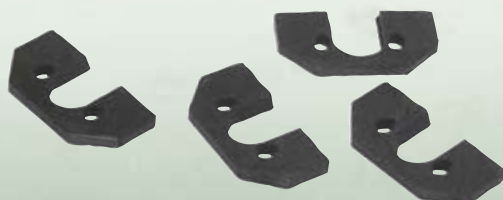

Trim Pro Shell Holders

The RCBS Trim Pro Case Trimmers feature unique shaped shell holders to firmly hold your rifle and pistol cases in perfect alignment with the cutter. This system allows for accurate and repeatable case trimming lengths and leaves the case mouths square to the body. The Trim Pro Shell Holders are numbered the same as our standard shell holders to make identification and use simpler. Available individually, or in pre-packs, for most popular rifle and pistol cartridges.

Trim Pro Shell Holders \$5.95

#1	90301	#21	90321
#2	90302	#23	90323
#3	90303	#24	90324
#4	90304	#25	90325
#5	90305	#26	90326
#6	90306	#27	90327
#7	90307	#28	90328
#8	90308	#30	90330
#9	90309	#32	90332
#10	90310	#33	90333
#11	90311	#34	90334
#12	90312	#35	90335
#13	90313	#36	90336
#14	90314	#37	90337
#15	90315	#38	90338
#16	90316	#39	90339
#17	90317	#40	90340
#18	90318	#41	90341
#19	90319	#42	90342
#20	90320	#43	90343
		#44	90344



Case Trimmer Collets

Works like a draw collet on a lathe. Secures cases for trimming to length. Refer to the reference chart on page 30 to determine the correct collet for a specific caliber.

For use with RCBS Rotary Case Trimmer and Rotary Case Trimmer-2 only

Case Trimmer Collets \$9.95

#1 - 09371	#2 - 09372
#3 - 09373	#4 - 09374



C A S E T R I M

New!

Hand Case Neck Turner

The RCBS Hand Case Neck Turner is designed to "peel" the brass from the outside of your case necks to a consistent thickness. Most commercially available brass has variances in the case neck thickness. This leads to case neck concentricity and bullet run-out issues. Truing up the case neck produces more consistent and accurate hand loaded ammunition. The cutter portion uses caliber specific pilot/mandrels (sold separately) to guide the case neck. The cutter design features the ability to "zero" the cutter to the pilot/mandrel and then use the micrometer adjustment to dial the desired case neck thickness in .0005" increments. The Cutter can also be set for right or left handed use.

The Quick Change Case Holder has many advantages over the competition. Most other units use a "tap wrench" design to hold cartridge cases. Though this is great for threading holes with a self feeding tap, it does nothing to feed your case neck to the cutter. The RCBS Quick Change Case Holder features an ergonomic design that allows you to rotate the case and put forward pressure to feed the case neck to the cutter. The quick case change feature helps to speed up the process without having to use small obtrusive thumbscrews.

90401	Hand Case Neck Turner with Quick Change Case Holder	\$64.95
90402	Quick Change Case Holder	\$29.95
90405-27	Hand CNT Pilot.17-.500	\$9.95

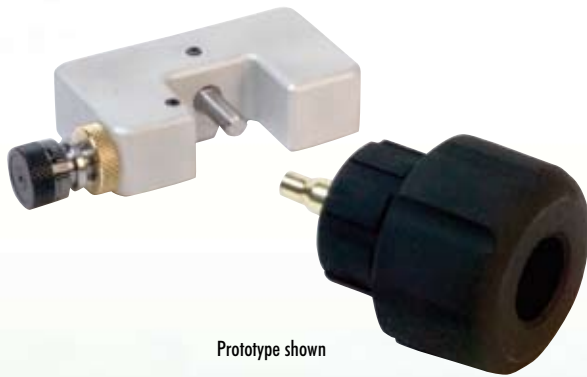

Prototype shown

Hand Case Neck Turner FEATURES & BENEFITS

- Micrometer adjustment .0005"
- Ability to "zero" the cutter to the pilot/mandrel
- Right or Left handed use
- Ergonomic Case Holder
- RCBS Lifetime warranty

Hand Case Neck Turner Pilots \$9.95

.17 Cal. Pilot	90405	.34 Cal. Pilot	90417
.20 Cal. Pilot	90406	.35 Cal. Pilot	90418
.22 Cal. Pilot	90407	.36 Cal. Pilot	90419
.24 Cal. Pilot	90408	.37 Cal. Pilot	90420
.25 Cal. Pilot	90409	.40 Cal. Pilot	90421
.26 Cal. Pilot	90410	.41 Cal. Pilot	90422
.27 Cal. Pilot	90411	.416 Cal. Pilot	90423
.28 Cal. Pilot	90412	.44 Cal. Pilot	90424
.30 Cal. Pilot	90413	.45 Cal. Pilot	90425
.31 Cal. Pilot	90414	.475 Cal. Pilot	90426
.32 Cal. Pilot	90415	.500 Cal. Pilot	90427
.33 Cal. Pilot	90416		

Case Neck Turning Accessories

Two tools for fast, easy removal of excessive neck thickness or variation in case thickness. They guide the cutter over the sized cartridge case neck and are supported by the special pilot/reamer. The inside and outside of the neck are turned simultaneously. The Auto Feed Attachment (for Case Trimmer-2 and Trim Pro Manual Case Trimmer) advances the cutting tool evenly over the case neck with each turn of the trimmer handle.

Not to be used with Trim Pro Power Case Trimmer.

98860	Case Neck Turner w/ Auto Feed	\$72.95
98861	Case Neck Turner	\$35.95

Pilot/Neck Reamers: \$9.95

98877	.17 Cal.	98883	7mm Cal.
98876	.20 Cal.	98884	.30 Cal.
98878	.223 Cal.	98886	8mm Cal.
98879	6mm/243 Cal.	98887	.338 Cal.
98880	.25 Cal.	98889	.35 Cal.
98881	6.5mm Cal.	98891	.375 Cal.
98882	.270 Cal.		



Case Neck Turner w/Auto Feed pictured above



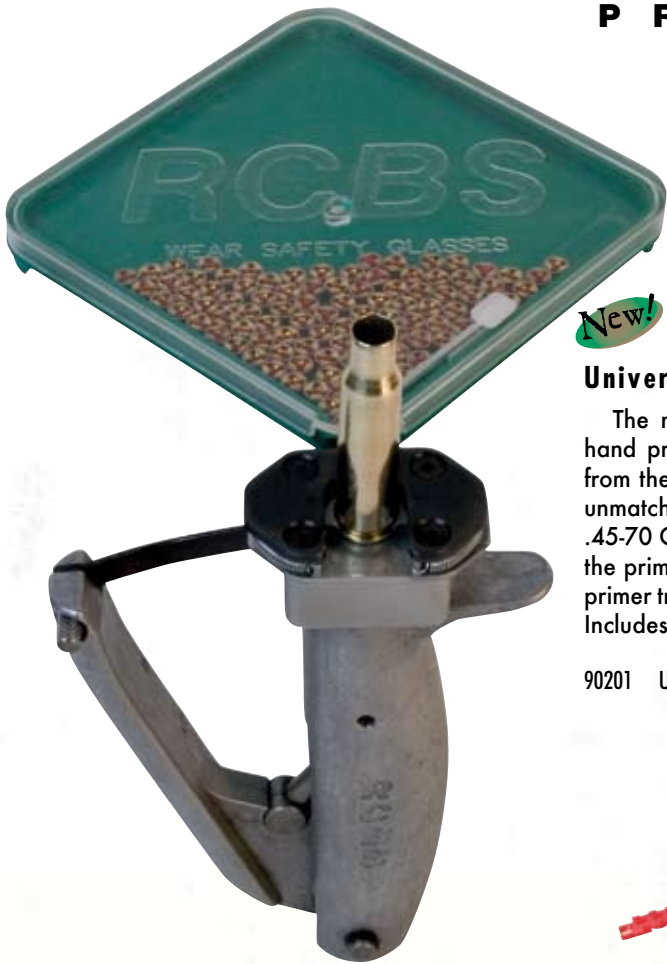

New!

Universal Hand Priming Tool

The new Universal Hand Priming tool combines features found on our other two hand priming tools into one convenient package. We took the universal shell holder from the APS tool and combined it with the primer tray from the standard tool to offer unmatched performance. The universal shell holder will accept cases from .32 ACP to .45-70 Government. The patented safety gate isolates the primer seating operation from the primer supply virtually eliminating the possibility of tray detonation. The removable primer tray orients your primers for use and will fit any manufacturers' primer packaging. Includes accessories to seat large and small rifle or pistol primers.

90201 Universal Hand Priming Tool \$51.95



APS® Hand Priming Tool

FEATURING UNIVERSAL SHELL HOLDER

Who hasn't dumped a load of primers onto a tray only to have half the box scatter all over the floor? Trying to figure out if those primers left in the tube were standard or magnum can also be a headache. Now you can eliminate those priming headaches.

It's fast and simple. The APS Hand Priming Tool is simply revolutionary! First, the Universal Shell Holder completely eliminates the need for additional shell holders, accepting case sizes from .32 ACP to .45-.70. Secondly, each strip is color-coded for easy identification and holds up to 25 primers. The primer strips are even designed to connect to each other for continuous feed. Now, there's no need to handle loose primers or worry about contamination.

The APS Hand Priming Tool is also completely portable. You're no longer tied down to your bench to prime. Hand priming has never been easier, safer, or more convenient!

88507 APS Hand Priming Tool \$49.95

Hand Priming Tool

Our hand priming tool not only seats primers quickly, it's also the safest. A patented safety mechanism separates the seating operation from the primer supply, virtually eliminating the possibility of tray detonation. Fits in your hand for portable primer seating. Primer tray installation requires no contact with the primers. Uses the same RCBS shell holders (post-1980) as RCBS presses. Made of durable cast metal. Includes large and small primer plugs.

90200 Hand Priming Tool \$37.95



Primer tray is easily removed for loading and can accommodate 100 primers

PRIMING - BENCH TOOLS



Automatic Priming Tool

The Automatic Priming Tool is fast, accurate and highly sensitive due to a unique single-stage lever system. Primers feed through the auto primer feed tube one by one, preventing potential contamination by oily fingers. Two primer rod assemblies and two primer feed tubes are included.

09460 Automatic Priming Tool \$87.95

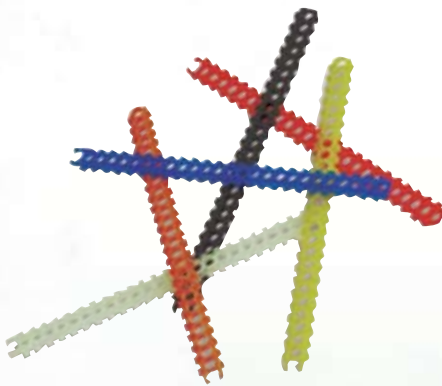

APS® Unprimed Primer Strips

These strips are color-coded for fool-proof identification. Each strip holds 25 primers. Strips can be loaded with the primer of your choice using the striploader. Primers not included.

APS Primer Strips (unprimed) \$4.95

APS Primer Strips

88510	APS Strip, Lg. Rifle 8/pk	Yellow
88511	APS Strip, Lg. Pistol 8/pk	White
88512	APS Strip, Sm. Rifle 8/pk	Yellow
88513	APS Strip, Sm. Pistol 8/pk	White
88514	APS Strip, Mag Lg. Rifle 8/pk	Blue
88515	APS Strip, Mag Lg. Pistol 8/pk	Red
88516	APS Strip, Mag Sm. Rifle 8/pk	Blue
88517	APS Strip, Mag Sm. Pistol 8/pk	Red
88518	APS Strip, BR2 Lg. Rifle 8/pk	Black
88519	APS Strip, BR4 Sm. Rifle 8/pk	Black
88520	APS Strip, 5.56mm Military 8/pk	Orange
88521	APS Strip, 7.62mm Military 8/pk	Orange

Strips automatically feed and can be interlocked for uninterrupted priming

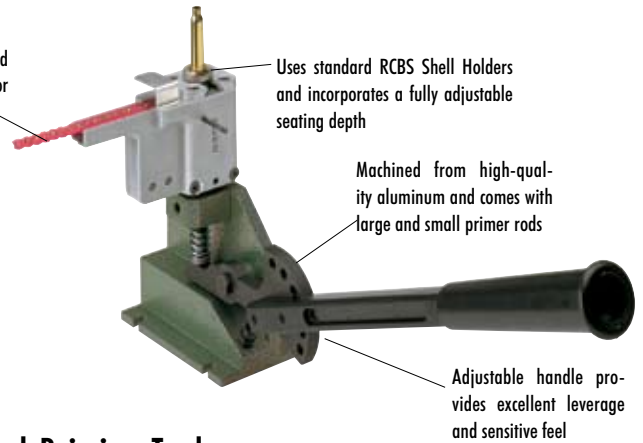

Uses standard RCBS Shell Holders and incorporates a fully adjustable seating depth

Machined from high-quality aluminum and comes with large and small primer rods

Adjustable handle provides excellent leverage and sensitive feel

APS® Bench-Mounted Priming Tool

The APS Bench-Mounted Priming Tool was created for those reloaders who prefer to have a separate, specialized tool dedicated just to priming. It's a tool with exceptional feel for concise and consistent seating of primers. The handle on the bench-mounted tool is large by design to provide hours of comfortable loading. Handle position is adjustable for bench height or personal preference.

88501 APS Bench-Mounted Priming Tool \$104.95

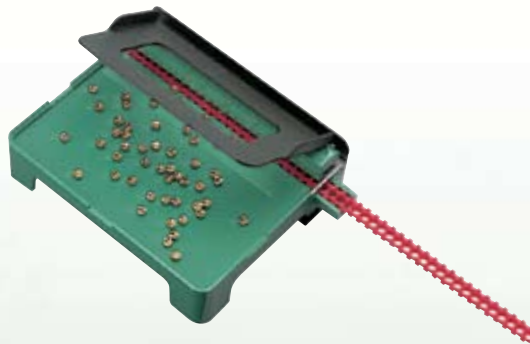

APS® Primer Strip Loader

For those of you who may already have a supply of CCI® or Federal® primers or any other brands in conventional packaging, not to worry...

The APS Primer Strip Loader allows you to quickly fill empty primer strips. It's simple to use and even faster than loading a primer tube! Each push of the handle safely inserts 25 primers into an APS strip for use with the RCBS APS® Priming System.

88505 APS Strip Loader \$31.95

Equipment readily secures to plate for quick tool change-overs. Makes the most of limited bench space



Accessory Base Plate-2

Save time, space and eliminate a loading bench top full of holes. Simply attach the Base Plate-2 to any work surface, then use the pre-tapped, letter-coded holes to quickly mount or dismount RCBS Case Trimmers, Trim Pro, Powder Measure Stand, Lube-A-Matic-2, Reloader Special, Rock Chucker, Pro 2000, AmmoMaster, Turret Press, Partner Press, and the APS Bench Mounted, Automatic and Standard Priming Tools. Fastening hardware included. Measures approximately 10" x 6" x 1".

09280 Accessory Base Plate-2 \$30.95

APS® Press-Mounted Priming Tool

For those of you who have limited bench space, or prefer priming cases on a press, we've designed the APS Press-Mounted Priming Tool just for you. It provides the same features as the APS Bench-Mounted Tool except it attaches to any single stage press that accepts standard 7/8"-14 dies.

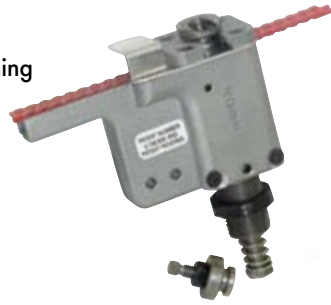

88503 APS Press-Mounted Priming Tool \$66.95

Automatic Primer Feed Combo

Drops primers one at a time into the Primer Plug and sleeve. Stops misfires as greasy fingers never need to touch primers. Nylon Primer Pick-up keeps primers from falling out. Tube capacity 100 primers. For Rock Chucker II Press; also fits "JR" and Reloader Special Presses.

**Not for use with RC Supreme*

- 09580 Auto Primer Feed Combo for large and small primers \$27.95
- 09581 Large Primer Tube Only \$12.95
- 09582 Small Primer Tube Only \$12.95



Ram Priming Unit

The Ram Priming Unit gives you better "feel" by seating the primer at the top of the press stroke. You can also pre-set a positive stop to speed up your reloading process. Works with any single stage or turret press with 7/8"-14 thread and RCBS-type single stage shell holder. Includes large and small primer rod assemblies for Boxer-type rifle and pistol primers.

09165 Ram Priming Unit \$20.95

.50 BMG Ram Priming Unit

The .50 BMG Ram Priming Unit in conjunction with the AmmoMaster Single Stage press allows you to re-prime this powerful cartridge. It comes supplied with a flat and cupped primer plug to accommodate the two styles of primers available for the .50 BMG.

88772 .50 BMG Ram Priming Unit \$44.95



Universal Primer Arm-2

Designed for fast, accurate primer seating. Primer plugs and sleeves included for large and small rifle and pistol primers. Changing sizes is fast and easy - less than 60 seconds. Fits Rock Chucker II, JR, Reloader Special and most "C" Presses.

**Not for use with RC Supreme*

- 09550 Universal Primer Arm for large and small primers \$13.95
- 09552 Primer Plug, sleeve and spring for large primers \$3.95
- 09553 Primer Plug, sleeve and spring for small primers \$3.95

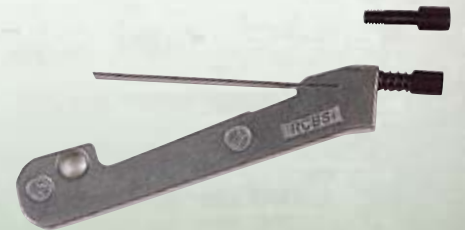

Primer Catcher

Made to keep spent primers off the floor when ejected from fired cases. Plastic clip holds Primer Catcher snug and secure to press. Easily removed for emptying. For Rock Chucker, "JR" and Reloader Special Presses only.



09114 Primer Catcher \$8.95

Primer Tray-2

The Primer Tray-2 handles today's larger primer package quantities. The square shape makes it easier to handle. Grooved tray surface quickly positions primers anvil-side up.

09480 Primer Tray-2 \$4.95



RC-130™ Mechanical Scale

1 The RC-130 low-cost scale has many of the same quality features that you find in our other scales. A precision-machined aluminum beam means that weight increments are accurate and repeatable. You don't get that in a scale with a plastic beam!

Beam poises are metal plates, just like higher-priced scales. They're designed to be easy to adjust and to stay put after you set them. True magnetic dampening completes the picture to allow fast, stable, and accurate readings. The critical beam pivots are steel-on-steel, not steel-on-aluminum like another company uses. The pivot bearings are cylindrical for the smallest possible contact area - ensuring better accuracy.

The RC-130 weighs to 130 grains with an accuracy of ± 0.1 grains. The sturdy base and easy-to-read index bar are molded from tough ABS polymer.

The non-static powder pan with integral hanger allows easy transfer of powder to the cartridge case. And naturally the RC-130 is backed by the RCBS Lifetime Warranty.

90400 RC-130 Mechanical Scale \$47.95

5-0-2 Scale

2 Big-scale features and capacity with an affordable price. Two-poise design lets you weigh up to 505 grains with ± 0.1 grain accuracy. The 5-0-2 also sports our magnetic dampening system for fast readings, maintenance-free movement and a rugged die-cast metal base. Tip-proof aluminum pan for loading convenience. Ounce-to-grain conversion table on the base for handy shotshell reference.

09069 5-0-2 Scale \$76.95
09075 Dust Cover \$8.95

5-0-5 Scale

3 The legendary standard in mechanical scales. The 5-0-5 features our magnetic dampening system plus large black-on-white graduations for fast recognition. Its three-poise beam is graduated in ten, one and 0.1 grain increments to achieve ± 0.1 accuracy. A tip-proof aluminum pan keeps powder from sticking or spilling. Hardened knife blades ride on agate bearings for long life and sensitivity. There's even ounce-to-grain conversion on the base for shotshell reloaders. Capacity: 511 grains.

09071 5-0-5 Scale \$93.95
09075 Dust Cover \$8.95

10-10 Scale

4 Need up to 1,010-grain capacity* with ± 0.1 -grain sensitivity? You get it with the RCBS 10-10. Its approach-to-weight system speeds reloading and helps you avoid overloads. A micrometer poise allows easy adjustment at any setting from 0.1 to 10 grains. Other features: magnetic dampening, non-stick/non-spill aluminum pan, self-aligning agate bearings, hardened steel pivot knives and a tough plastic cover.

09073 10-10 Scale \$158.95

*With included attachment weight



RangeMaster™ 750

The new RangeMaster 750 Scale has a sleek design with many convenient features. The compact lightweight scale can operate on AC or DC power so it is perfect for use on your reloading bench or at the range. The large LCD display is easy to read in grains or grams and weighs precisely to +/- 0.1 grain. Capacity is 750 grains. The RangeMaster Scale comes equipped with two precision calibration/check weights and an AC adaptor (9V battery not included). The RCBS RangeMaster 750 is the perfect choice for the serious shooter that demands the best performance, value and portability.

- 98927 RangeMaster 750 110VAC/9VDC \$132.95
- 98926 RangeMaster 750 220VAC-EUR/9VDC \$132.95



Scale Check Weights

You rely on your scale for safe, accurate powder charges. Over time, accumulated grit and dust can affect accuracy. A quick test with RCBS Scale Check Weights will tell you if your scale is reading correctly. Sets include: Standard set of 60.5 grains for powder charges (2x20, 1x10, 1x5, 2x2, 1x1, 1x.5). Deluxe set of 510.5 grains for bullets, cases and powder (1x 200, 2x100, 1x50, 2x20, 1x10, 1x5, 2x2, 1x1, 1x.5, 1 forceps).

- 98990 Standard Scale Check Weights \$29.95
- 98992 Deluxe Scale Check Weights \$51.95
- 09078 Scale Pan (5-0-2, 5-0-5, 5-10 & 10-10 scales) \$15.95
- 09079 Scale Pan Support (5-0-2, 5-0-5, 5-10 & 10-10 scales) \$18.95

ChargeMaster™ 1500

The new ChargeMaster 1500 Scale is built from the ground up as a high performance reloading scale. The large LCD display is easy to read in grains or grams and weighs precisely to +/- 0.1 grain. With a 1500 grain capacity you can weigh powder, bullets, cases or loaded cartridges. The scale is fast and easy to calibrate with the two calibration/check weights that are included. AC adaptor is included. The ChargeMaster 1500 Scale was designed for the serious shooter that wants the best high tech scale on the market. The ChargeMaster 1500 Scale can be operated as an independent electronic scale or it can be upgraded to an automated powder dispensing system with the addition of the ChargeMaster Dispenser (shown on page 24).

- 98920 ChargeMaster 1500 110VAC \$208.95
- 98921 ChargeMaster 1500 220VAC-EUR \$208.95



ChargeMaster Combo

The ChargeMaster Combo features the ChargeMaster 1500 Scale and ChargeMaster Dispenser, preassembled to form an unmatched combination of speed and accuracy. There is no longer a need for timely calibration to the type of powder being used. Simply fill the 1 lb+ capacity powder hopper with smokeless powder, enter the desired charge and press the dispense button. Average dispensing time is under 30 seconds for a 60 grain extruded powder charge. Dispensing can be done in grains or grams mode. Accurately weighs and dispenses all extruded (stick), ball (spherical) and flake smokeless powder from 2.0 to 300 grains to +/- 0.1 grain. You can store up to 30 of your favorite loads in memory for fast easy recall. The front to back layout allows easy access to the scale pan by right or left handed users. The clear cover eliminates fluctuations in weighing caused by air currents without obscuring your view of the charge being dispensed. The powder drain feature allows for convenient and easy emptying of the powder hopper. Power to the Dispenser is provided by the connection to the ChargeMaster 1500 scale so there is only one power cord to manage. The ChargeMaster 1500 Scale and dispenser can be purchased separately or as a Combo set.

Note: Use with smokeless powder only. Do NOT use with black powder! ⚠

98923	ChargeMaster Combo 110VAC	\$397.95
98924	ChargeMaster Combo 220VAC-EUR	\$397.95

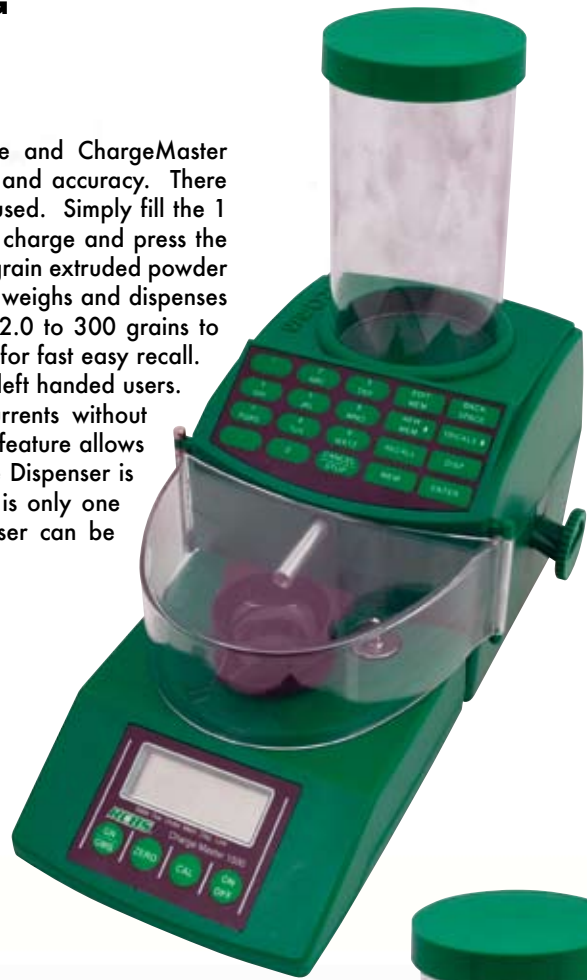

ChargeMaster Dispenser

The ChargeMaster Dispenser can be added to the ChargeMaster 1500 Scale to form an unmatched combination of speed and accuracy. When the ChargeMaster Dispenser is coupled with the ChargeMaster 1500 Scale, it now has all of the same features as the ChargeMaster Combo. The individual purchasing of the units is to accommodate individual budgets. The ChargeMaster Dispenser requires the ChargeMaster 1500 Scale (sold separately) to operate.

Note: Use with smokeless powder only. Do NOT use with black powder! ⚠

98922	ChargeMaster Dispenser only	\$225.95
-------	-----------------------------	----------



New!

Quick Change Powder Measure

The new RCBS Quick Change Powder Measure offers the ability to go from light pistol to magnum rifle charges quickly. The powder hopper has been increased in size to hold a pound of smokeless powder. The QCPM features metering assemblies that change out with the pull of a pin. Extra metering assemblies can be purchased to have them preset for your favorite smokeless powder charges. The drain attachment empties the powder hopper without the need to remove it from the stand or press. The Quick Change Powder Measure includes one each Small and Large Metering Assembly and the Drain Attachment. The Quick Change parts can be used to upgrade your existing Uniflow powder measure to this system.

Do not use with Black Powder! ⚠️

98840 Quick Change Powder Measure	\$90.95
98843 QC Small Metering Screw Assembly	\$14.95
98844 QC Large Metering Screw Assembly	\$9.95
98845 QC Metering Cylinder	\$24.95
98846 QC Drain Attachment	\$8.95
98855 QC Drop Tube Adaptor	\$TBD



Shown with optional Powder Measure Stand

New!

Quick Change Accessories

The Quick Change Accessories can be used to upgrade your existing Uniflow powder measure to this system. You simply replace the metering cylinder and metering screw that came with your Uniflow with the Quick Change accessories.

The QC Drop Tube Adaptor allows you to use the drop tubes from the QC High Capacity powder measure or the Drop Tube and Adapters from the Quick Change Powder Funnel on your Uniflow or Quick Change powder measure.

New!

Quick Change High Capacity Powder Measure

The new RCBS High Capacity Quick Change Powder Measure offers the ability to dispense large rifle charges of up to 240 grains of smokeless powder. The large hopper can accommodate two pounds of smokeless powder. The HCQCPM features metering assemblies that change out with the pull of a pin. Extra metering assemblies can be purchased to have them preset for your favorite charges. The drain attachment empties the powder hopper without the need to remove it from the stand or press. Includes one metering assembly, .22-.270 Drop tube, .30-.45 Drop Tube, .50 Drop Tube and the QCHC Drain Attachment.

Do not use with Black Powder! ⚠️

98841 Quick Change High Capacity Powder Measure	\$110.95
98849 QC HC Metering Screw Assembly	\$16.95
98850 QC HC Drain Attachment	\$9.95
98852 QC Drop Tube .22-.270	\$TBD
98853 QC Drop Tube .30-.45	\$TBD
98854 QC Drop Tube .50	\$TBD



Shown with optional Powder Measure Stand



New!

QUICK CHANGE HIGH CAPACITY ACCESSORIES

The Quick Change High Capacity Metering assembly is available so that you can preset them to your favorite large capacity rifle charges such as 110 grains for your 30-378 WBY or 120 grains for the 600 Nitro Express.

The QC High Capacity Drop Tubes, in conjunction with the QC Drop Tube Adaptor, allow the use of these on existing Uniflow or QC powder measures.

New!

Scale Pan w/Integrated Funnel

Is your powder funnel always missing when you need it most? The new RCBS® Scale Pan Powder Funnel eliminates that problem. The Scale Pan features an integrated powder funnel that allows you to pour the powder directly into the case. The new scale pan is designed for use with electronic scales and powder dispensers.

09090 Scale Pan w/Integrated Funnel — \$5.95



Prototype Shown

Improved!

Powder Funnel



We've even managed to improve upon the basic plastic funnel. Ours features a specially designed drop tube to avoid any messy powder spills around case mouths, a non-stick, anti-static surface, plus a square lip to keep the funnel from rolling around. Spout will accommodate the WSM cartridges.

09087 Powder Funnel .22 to .45 Cal. \$4.95
 09086 Powder Funnel .17 to .20 Cal. \$6.95

New!

Quick Change Powder Funnel



With the current trend of large bodied rifle cases, existing powder funnels sometimes do not fit properly over the cases. The new RCBS® Quick Change Powder Funnel eliminates that problem. The QC Powder Funnel features adapters that are supported by the body of the case and allow you to choose the optimum powder flow. The 4" drop tube helps to get that compressed powder charge into the case. The drop tubes are stackable so you can increase the drop length if necessary. With the adapters removed, the powder funnel allows you to return powder into the original container quickly.

9190 Quick Change Powder Funnel Kit (Funnel, 5 adapters and one drop tube) \$9.95
 9191 Quick Change drop tube \$TBD
 9192 Adapter .17-.20 (.17 Rem, .204 Ruger, .218 Bee, .22 Hornet) \$TBD
 9193 Adapter .22-.264 (.222 Rem, .223 WSSM, .243 Win, 6.5x55) \$TBD
 9194 Adapter .27-7mm (.270 Win, 7mm Ultra Mag, .32 ACP) \$TBD
 9195 Adapter .30-.375 (.30-30 Win, .338 Win Mag, .375 H&H, .357/38 Spl, 9mm, .32 H&R) \$TBD
 9196 Adapter .40+ (.416 Rem, .460 Wby, .40/10mm, .41/.44 Mag, .45 ACP, 500 S&W) \$TBD

Powder Trickler

Here's the fast way to feed powder to your scale. Turn the small knob and powder trickles into the pan one kernel at a time. Large-capacity reservoir, extra-wide base for stability, and a perfect height for all powder scales.

09094 Powder Trickler \$14.95



Competition Powder Measure

The Competition Powder Measure starts with the proven Uniflow Powder Measure with its precision ground metering drum and honed main casting. RCBS then adds a powder baffle and UPM Micrometer Adjustment screw. The Powder Baffle controls the powder flow and the pressure of the powder column on the metering unit. The UPM Micrometer Adjustment screw allows precise adjustments to the metered charge as well as allowing you to record the number for future reference and reuse. Handle placement can be used on the right or left side simply by changing the orientation of the metering drum. The powder measure will accurately meter, by volume, all types of smokeless powder - ball, flake or cylindrical (stick).

The Rifle unit meters volumetric powder charges from 10-110 grains. The Pistol/Small Rifle unit meters volumetric powder charges from .5 to 40 grains. The Combo unit includes both the Rifle and Pistol metering drums and complete UPM Micrometer Adjustment screw assemblies.

Note: All powder measures should be used in conjunction with an accurate powder scale to set the desired charge and to occasionally check charges during the reloading process.

*Not for use with Black Powder. 

98908 Competition Powder Measure - Pistol/Small Rifle \$123.95
 98909 Competition Powder Measure - Rifle \$123.95
 98910 Competition Powder Measure - Combo \$185.95



Shown with optional Powder Measure stand, not included

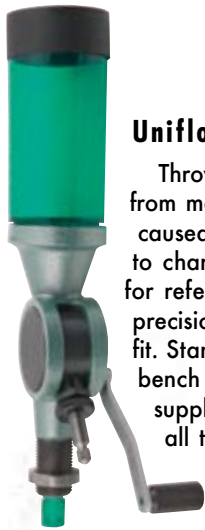

Uniflow™ Powder Measure

Throws consistently accurate charges reload after reload. Powder pours uniformly from measuring cylinder into case, thereby eliminating the hazards of "overloads" caused by clogging when charges are "dumped". Changes easily from charge to charge without emptying powder hopper. Numbered measuring screw is used for reference to find a given charge at a later date. The measuring cylinder has precision ground surfaces and slides into the honed main casting for a precision fit. Standard 7/8"-14 thread. Includes stand plate, drilled for easy mounting on a bench or under a reloading die lock ring. Two drop tubes for .22 caliber and up are supplied. The Uniflow Powder Measure is fully capable of accurately measuring all three major powder types - ball, cylindrical and flake. It will even cut the cylindrical powders so that a precise charge can be obtained.

Note: The Uniflow Powder Measure should be used in conjunction with an accurate powder scale for setting the original charge and for checking charges occasionally during the run.

*Not for use with black powder. ⚠️

An optional 17 caliber drop tube is available

09010	Uniflow Powder Measure	\$87.95
09002	Uniflow Powder Measure Small	\$90.95
09004	Measure Cylinder Assembly Small	\$31.95
86880	Dust Cover	\$9.95
09028	Drop Tube .17 to .20 Cal.	\$8.95

Micrometer Adjustment Screw for Uniflow™ Powder Measure

The secret to faster reloading—go by the numbers. Add the UPM Micrometer to your Uniflow Powder Measure, and you can record precise settings for your powder charges. Determine the load number and dial it in - time after time. An easy installation too; it simply replaces the Uniflow's standard metering screw.

UPM Micrometer Adjustment Screws		
98901	Large .685" diameter	\$44.95
98902	Small .500" diameter	\$44.95



Powder Measure/ Piggyback Stand

This stand will raise any powder measure (with standard 7/8"-14 thread) leaving plenty of space for positioning a powder scale pan or cases in a loading block under the drop tube. Bolts easily to a reloading bench or table. Also serves as a stand for holding a Piggyback II, -3 or -4 when not in use.

09035	Powder Measure/ Piggyback Stand	\$27.95
-------	---------------------------------	---------

Reloading Accessory Kit

This package makes reloading even easier with some nice tools. The Reloading Accessory Kit includes: Powder Measure/Piggyback Stand, Powder Trickler, Primer Pocket Brush Combo, Case Loading Block, Stainless Steel Dial Caliper, small and medium size Case Neck Brushes.

98925	Reloading Accessory Kit	\$119.95
-------	-------------------------	----------

Case Activated Linkage Kit

Convert the Uniflow Powder Measure (not included) for use on most four or five-station progressive presses. The Uniflow Powder Measure can have the regular Measuring Screw or the optional Micrometer Adjustment Screw installed, depending on your preference. Three powder bushings are included for most popular rifle and pistol calibers: Small Rifle for .22 through .270 calibers, Large Rifle for 7mm through 45 calibers and Pistol for .32 through .45 calibers. The powder bushings are designed to eliminate powder spillage around the case mouth. Fully adjustable for all of the different variations in case length.



98911	Case Activated Linkage Kit	\$70.95
-------	----------------------------	---------

Powder Baffle

Uniform loads require consistent powder charges, and many handloaders find a baffle helps them throw more consistent charges. The baffle is specifically designed for the Uniflow Powder Measure and provides handloaders a uniform powder flow by controlling the gravity feed pressure of the powder column on the metering unit.

Powder Baffle fits inside of powder hopper and provides more even flow of powder



90225	Powder Baffle	\$6.95
-------	---------------	--------

		Powder Charge Weight in Grains																												
GRAINS	14	15	16	17	18	19	20	21	22	23	24	25	26	27	28	29	30	31	32	33	34	35	36	37	38	39	40	41	42	43
Accurate Solo 1000	387	399	411	420	432	438	447	459	474																					
Accurate Solo 1250	369	384	396	408	420	429	441	453	459	471	480	492	501	510	516	525	537	543	555	558										
Accurate No. 2 Improved				357	366	378	387	396	408	417																				
Accurate Nitro 100	375	387	399	411	423	435	447	456	465																					
IMR 700-X		402	414	429	441	453	465	471	486	498																				
IMR PB	366		390	402	414	426	435	447	456	465	474	486																		
IMR SR 7625	345			381	390	402	414	426	438	444	453	462	474	486																
IMR 800-X	372	390	402	414	423	429	438	447	459	468	480			507	525			534		549	558									
IMR SR 4756	366				408		426	435	447	459	471	480						525	534		549	558				580	588			
IMR 4227									366		390			408	414	420	426	435	441	447	453	462	468	474	480	486		498		
Alliant American Select			417	423	432	447	456	468	477	483																				
Alliant Red Dot/E3		405	423	438	453	468	480	489	498	510	519																			
Alliant Green Dot	390	405	420	435	447	456	468	480	492	501	513	522	534		549	558														
Alliant Unique	354	369	381	393	405	414	423	435	444	453	465	474	483	492	501			510												
Alliant Herco	369	381	393	405	414	426	438	450	462	471	477	489	498	513	522	531			549	558	564	573			588	594				
Alliant Blue Dot				366	372	381	390	396	408	414	423	435	441	447	459	468	474	483	489	495	501	510	516	522	531	534	543	549	555	
Alliant 2400	291	300	312	324	330	339																								
Hodgdon Clays			429	441	456	468	483	495	507																					
Hodgdon International	375	390	402	414	423	435	447	459	471	483	495	507																		
Hodgdon Universal	342	354	366	378	390	402	411	420	429	438	447	456	468	480	489	501														
Hodgdon HS-6			300	309	318	327	336	345	357	360	366	375	381	387	393	402	408	414	423	429										
Hodgdon HS-7					318	330	339	348	357	363	369	378	384	390	396	405	411	417	423	429	438	444	450							
Hodgdon Titewad		384	396	408	420	432	441	453	462	474	486	492																		
Hodgdon Longshot	300	309	318	330	345	348	357	366	372	381	390	396	405	414	423	429	435	444	450	459	465	471	480	486	492	498				
Hodgdon Titegroup		324	330	342	351	360	369	378	387	396	405																			
Winchester 540			300	309	318	327	336	345		360	366			381			402	408	414	423	429	435	441	444	450	459	465	471		
Winchester 571					318									390	396					423	429	438	444	450	456	462	468	474	480	486
Winchester Super Target					414	429	438	450	459	471	480																			
Winchester Super Lite				345	354	363	372	381	390	402																				
Winchester Super Field			327	345	354								420	426	432	441	450	456	462											

How To Select Bushings for Half Grain Charges:

Powder bushings are identified by numbers that correspond to the size of their inside diameter. (For instance, the inside diameter of the #456 bushing is .456 inches.) Bushings for powder charges in half-grain increments can be calculated from this chart. Simply, "split the difference" between the two even-grain bushings, and select the bushing nearest the result. Example: To find the bushing for 18 1/2 grains of Hercules Red Dot powder, note that bushing #468 gives a charge of 18 grains and that bushing #480 gives 19 grains. Split the difference between 468 and 480, and the result is 474. Thus, the

correct bushing for 18 1/2 grains of Red Dot is bushing #474. All charges listed on this chart are an average of several loads weighed following the complete reloading cycle. Powders used in establishing these loads were from ballistic samples supplied by the manufacturer or sealed tins of recent manufacture. Charges may vary slightly due to operator's technique and/or powder variables. Always check actual charge weight against recommended charges and adjust bushing size as necessary.

Bushings listed, but not offered from RCBS, can be obtained from other manufacturers.

The GRAND, Powder Bushings							
<small>Suggested Retail Price \$5.95</small>							
Part Number	Bushing#	Part Number	Bushing#	Part Number	Bushing#	Part Number	Bushing#
89111	354	89119	408	89127	438	89135	462
89112	360	89120	414	89128	441	89136	465
89113	366	89121	420	89129	444	89137	468
89114	372	89122	423	89130	447	89138	471
89115	381	89123	426	89131	450	89139	474
89116	390	89124	429	89132	453	89140	480
89117	396	89125	432	89133	456	89141	486
89118	402	89126	435	89134	459	89142	498

The GRAND, Charge Bar	
89100	\$18.95



Interchangeable Charge Bushings:

For use with THE GRAND shotshell reloader. Designed so shot and powder bushings cannot be accidentally reversed in the charge bar. The bushings make it easy to change from one load to another.



Powder Bushing

The GRAND, LEAD SHOT BUSHINGS	
<small>For Field Loads #6's</small>	
<small>Compensates for tighter packing of smaller shot size</small>	
<small>Suggested Retail \$5.95</small>	
Part Number	Bushing
89170	7/8 oz.
89171	1 oz.
89172	1-1/8 oz.
89173	1-1/4 oz.
89174	1-3/8 oz.
89175	1-1/2 oz.

The GRAND, LEAD SHOT BUSHINGS	
<small>For Target Loads</small>	
<small>Calibrated to measure maximum legal loads for trap and skeet shooting</small>	
<small>Suggested Retail \$5.95</small>	
Part Number	Bushing Description
89188	7/8 oz. #9
89189	1 oz. #7-1/2
89190	1 oz. #8
89191	1-1/8 oz. #7-1/2
89192	1-1/8 oz. #8
89193	1-1/8 oz. #8-1/2
89194	1-1/8 oz. #9



Shot Bushing

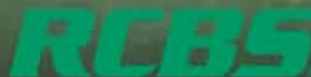

R E F E R E N C E C H A R T

Caliber	Die Group	Shell Holder & Shell Plate Number	Primer Plug & Sleeve Size	Case Trimmer Collet Number*	Rotary Case Trimmer Pilot Caliber	Plastic Ammo Box Size	Lube Die
.17 Remington	A	10	Small	1	17	SR	1
.204 Ruger	A	10	Small	1	20	SR	1
.218 Bee	A	1	Small	2	22	MP	-
.22 Hornet	A	12	Small	2	22	MP	-
.22 K-Hornet	D	12	Small	2	22	MP	-
.22 Remington Jet	D	6	Small	3	22	MP	-
.22 Savage High-Power	D	2	Large	2	22	MR	3
.22-250 Remington (22 Varminter)	A	3	Large	1	22	MR	2
.220 Swift	A	11	Large	1	22	MR	3
.221 Remington Fireball	A	10	Small	1	22	SR	1
.222 Remington	A	10	Small	1	22	SR	1
.222 Remington Magnum	A	10	Small	1	22	SR	1
.223 Remington (5.56mm)	A	10	Small	1	22	SR	1
.223 Winchester Super Short Mag	A	43(5)	Large	1	22	(4)	-
5.6mm x 50 Rimmed	D	6	Small	2	22	SR	-
5.7mm x 28 (FN)	A	45	Small	4	22	SR/MP	-
.240 Weatherby Magnum	A	3	Large	1	24	LR	2
.243 Winchester Super Short Mag	A	43(5)	Large	1	24	(4)	2
.243 Winchester	A	3	Large	1	24	MR	2
6mm PPC	A	32	Small	3	24	MR	1
6mm Remington (244 Remington)	A	3	Large	1	24	MR	2
.25 Auto (25 ACP)	E	29 (6)	Small	(4)	(4)	(4)	-
.25 Winchester Super Short Mag	A	43(5)	Large	1	25	(4)	-
.25-06	A	3	Large	1	25	LR	2
.25-20 Winchester	A	1	Small	2	25	MP	-
.25-35 Winchester	A	2	Large	2	25	MR	3
.250 Savage (250-3000 Savage)	A	3	Large	1	25	MR	2
.257 Roberts	A	3/11	Large	1	25	MR	2
.257 Roberts Improved 40"	D	3/11	Large	1	25	MR	2
.257 Weatherby Magnum	A	4	Large	1	25	LR	4
.260 Remington	A	3	Large	1	26	MR	2
.264 Winchester Magnum	A	4/26	Large	1	26	LR	4
6.5 Remington Mag	D	4/26	Large	1	26	LR	4
6.5mm-06	D	3	Large	1	26	LR	2
6.5-284 Winchester	D	3	Large	1	26	LR	4
6.5mm x 54 Mannlicher-Schoenauer	D	9	Large	1	26	LR	-
6.5mm x 55 Swedish Mauser	A	2	Large	1	26	LR	2
6.5mm x 57 Mauser	D	3	Large	1	26	LR	2
6.5mm x 68S	D	34(5)	Large (2)	2	26	LR	4
6.8 Remington SPC	A	19	Large	2	27	MR	3
.270 Weatherby Magnum	A	4	Large	1	27	LR	4
.270 Winchester	A	3	Large	1	27	LR	2
.270 Winchester Short Magnum	A	43(5)	Large	1	27	(4)	-
.280 Remington (7mm Exp. Rem.)	A	3	Large	1	28	LR	2
.284 Winchester	A	3	Large	1	28	MR	4
7mm Benchrest Remington	D	3	Small	1	28	MR	2
7mm Remington Magnum	A	4/26	Large	1	28	LR	4
7mm Remington SA Ultra Magnum	A	38/4(5)	Large	1	28	(4)	-
7mm Remington Ultra Magnum	A	38/4(5)	Large	1	28	(4)	-
7mm Shooting Times Westerner	A	4	Large	1	28	LR	4
7mm Thompson/Center Ugalde	A	10	Small	1	28	SR	1
7mm Weatherby Magnum	A	4	Large	1	28	LR	4
7mm Winchester Short Magnum	A	43(5)	Large	1	28	(4)	-
7mm-08 Remington	A	3	Large	1	28	MR	2
7mm x 57 Mauser (7mm Mauser)	A	3/11	Large	1	28	LR	2
7mm x 64 Brenneke	A	3	Large	1	28	LR	2
7mm x 65 Rimmed	D	26	Large	1	28	LR	2
7-30 Waters	A	2	Large	2	28	MR	3
.30 M-1 Carbine	C	17	Small	3	30	MP	-
.30 Luger (7.65mm Luger)	A	16	Small	2	30	(4)	-
.30 Mauser (7.63mm Mauser)	D	16	Small	2	30	(4)	-
.30 Remington	D	19	Large	2	30	MR	3
.30-06 Springfield	A	3	Large	1	30	LR	2
.30-30 Winchester	A	2	Large	2	30	MR	3
.30-338 Winchester Magnum	D	4	Large	1	30	LR	4
.30-378 Weatherby Magnum	A	14(5)	Large	4	30	(4)	-
.30-40 Krag	A	7	Large	3	30	LR	-
.300 H&H Magnum	D	4	Large	1	30	LR	4
.300 Remington SA Ultra Magnum	A	38/4(5)	Large	1	30	(4)	-
.300 Remington Ultra Magnum	A	38/4(5)	Large	1	30	(4)	-
.300 Savage	A	3	Large	1	30	MR	2
.300 Weatherby Magnum	A	4	Large	1	30	LR	4
.300 Winchester Magnum	A	4/26	Large	1	30	LR	4
.300 Winchester Short Magnum	A	43(5)	Large	1	30	(4)	-
.303 British	A	7	Large	1	31	LR	-
.307 Winchester	A	2	Large	2	30	MR	2
.308 Norma Magnum	D	4	Large	1	30	LR	4
.308 Winchester	A	3	Large	1	30	MR	2
7.5mm x 54 French MAS	D	2	Large	1	30	LR	2
7.5mm x 55 Schmidt-Rubin	A	2	Large	2	30	LR	-
7.62mm x 39-.308/.311	A	32	Large	3	30/31	MR	3
7.62mm x 54R Russian	A	13 (5)	Large	4	30	LR	-

Caliber	Die Group	Shell Holder & Shell Plate Number	Primer Plug & Sleeve Size	Case Trimmer Collet Number*	Rotary Case Trimmer Pilot Caliber	Plastic Ammo Box Size	Lube Die
7.65mm x 53 Belgian Mauser	A	3	Large	1	31	LR	2
7.7mm x 58 Japanese Arisaka	A	3/2	Large	1	31	LR	2
.32 Automatic (7.65mm Auto)	B	17	Small	1	31	(4)	-
.32 H&R Magnum	E	23	Small	1	31	(4)	-
.32 Smith & Wesson Long	E	23	Small	1	31	(4)	-
.32 Winchester Special	A	2	Large	2	32	MR	3
.32-20 Winchester	E	1	Small	2	31	MP	-
.32-40 Winchester	D	2	Large	2	32	MR	3
8mm Remington Magnum	A	4	Large	1	32	LR	4
8mm-06	D	3	Large	1	32	LR	2
8mm x 57 Mauser (8mm Mauser)	A	3	Large	1	32	LR	2
8mm x 68S Magnum	D	34 (5)	Large (2)	2	32	LR	-
.325 Winchester Short Magnum	A	43 (5)	Large	1	32	(4)	-
.338 Federal	A	3	Large	1	33	MR	2
.338 Lapua	A	14/37(6)	Large	4	33	(4)	-
.338 Remington Ultra Magnum	A	38/4(5)	Large	1	33	(4)	-
.338 Winchester Magnum	A	4	Large	1	33	LR	-
.338-06	D	3	Large	1	33	LR	2
.338-378 Weatherby Magnum	A	14	Large	4	33	(4)	-
.340 Weatherby Magnum	A	4	Large	1	33	LR	4
.348 Winchester	D	5 (5)	Large	4	34	MR	-
.35 Remington	A	9	Large	1	35	MR	3
.35 Whelen	A	3	Large	1	35	LR	2
.350 Remington Magnum	D	4	Large	1	35	MR	4
.356 TSW	B	16	Small	2	35	(4)	-
.356 Winchester	A	2	Large	2	35	MR	2
.357 Magnum	B	6	Small	3	35	MP	-
.357 Remington Maximum	B	6	Small	3	35	SR	-
.357 Sig	A	27	Small	3	35	LP	-
.358 Winchester	A	3	Large	1	35	MR	2
9mm FAR	E	16	Small	2	35	MP	-
9mm Luger	B	16	Small	2	35	(4)	-
9mm Makarov	E	16	Small	2	35	(4)	-
9mm x 21	B	16	Small	2	35	(4)	-
9mm x 23 Winchester	B	16	Small	2	35	(4)	-
9.3mm x 62 Mauser	A	3	Large (2)	1	36	LR	2
9.3mm x 74R	D	4	Large	1	36	LR	-
.375 H&H Magnum	A	4	Large	1	37	LR	4
.375 Remington Ultra Mag	A	38/4(5)	Large	1	37	(4)	-
.375 Winchester	C	2	Large	2	37	MR	3
.376 Steyr	D	42	Large	2	37	LR	4
.378 Weatherby Magnum	D	14 (5)	Large	4	37	(4)	-
.38 Colt Super Auto	E	39	Small	2	35	MP	-
.38 Smith & Wesson	B	6	Small	3	35	MP	-
.38 Special	B	6	Small	3	35	MP	-
.380 Automatic Pistol	B	10	Small	1	35	(4)	-
.38-40 Winchester	E	35 (5)	Large	1	40	LP	-
.38-55 Winchester & Ballard	LEGACY	2	Large	2	37	MR	3
.40 S&W	B	27	Small	3	40	LP	-
.400 CorBon	D	3	Large	1	40	LP	2
.40-65 Shiloh Sharps - 408"	LEGACY	14(5)	Large	4	41	(4)	4
.40-70-2 1/2" Sharps Straight	LEGACY	14(5)	Large	4	41	(4)	4
.405 Winchester	LEGACY	24	Large	3	40	(4)	3
10mm Auto	B	27	Large	3	40	LP	-
.41 Magnum	B	30	Large	2	41	LP	4
.416 Remington Magnum	D	4	Large	1	416	LR	-
.416 Rigby	D	37 (5)	Large	4	416	(4)	-
.44 Magnum	B	18	Large	2	44	LP	-
.44 Special	B	18	Large	2	44	LP	-
.444 Marlin	C	28	Large	1	44	LR	-
.44-40 Winchester	B	35 (5)	Large	1	44	LP	-
.45 Automatic (45 ACP)	B	3	Large	1	45	LP	2
.45 Auto Rim	B	8	Large	1	45	LP	2
.45 Glock Action Pistol	B	3	Large	1	4	LP	2
.45 Colt	B	20	Large	1	45	LP	-
.45-90-2.4" Sharps Straight	LEGACY	14(5)	Large	4	45-R	(4)	4
.45-100-2.6" Sharps Straight	LEGACY	14(5)	Large	4	45-R	(4)	4
.45-110-2 7/8" Sharps Straight	LEGACY	14(5)	Large	4	45-R	(4)	4
.45-120-3 1/4" Sharps Straight	LEGACY	14(5)	Large	4	45-R	(4)	4
.45-70 U.S. Government	C	14 (5)	Large	4	45-R	(4)	4
.450 Marlin	C	4	Large	1	45-R	LR	4
.454 Casull	B	20	Large	1	45	(4)	-
.458 Winchester Magnum	C	4	Large	1	45-R	LR	4
.458 Lott	C	4	Large	1	45-R	LR	4
.460 Weatherby Magnum	D	14 (5)	Large	-	45	(4)	-
.460 Smith & Wesson	B	4	Large	4	45	(4)	-
.475 Linebaugh 1.400"	B	40 (5)	Large	1	475	(4)	-
.480 Ruger	B	40 (5)	Large	1	475	(4)	-
.50 Action Express	B	33 (5)	Large	1	50	(4)	-
.50-70 Gov't	LEGACY	31(5)	Large	4	50	(4)	4
.50-90-2 1/2" Sharps Straight	LEGACY	31(5)	Large	4	50	(4)	4
.500 Smith & Wesson	B	44(5)	Large	-	50	(4)	-

IMPORTANT: Dies listed under Groups A, B, C, D, E and F are Standard Dies. If the caliber of dies you require is not listed, please call for availability. RCBS Shell Holder numbers do not correspond to those of other manufacturers. When two Shell Holder numbers are listed, the most popular is shown first. It may be necessary to use the alternate, depending on the manufacturer and/or lot of cases being used. The numbers in () in the table indicates the following: (1) Order Shell Holder by caliber. (2) Cases may be Berdan primed. Depriming and priming must be done by hand. If cases were formed from cases having boxer-type primer, use the appropriate Shell Holder for the caliber. (4) Not available. (5) Auto 4x4 Shell Plate not available. (6) Auto 4x4 and Five-Station Shell Plates not available. (7) Use #14 for Lapua brass, #37 for Norma brass. The letter codes in the Plastic Ammo Box Size column indicate the following: SR = Small Rifle, MR = Medium Rifle, LR = Large Rifle, MP = Medium Pistol, LP = Large Pistol. * Used only with Rotary Case Trimmer and Rotary Case Trimmer-2.

Precisioneered™ Dies

At RCBS we have over 50 years of precision die making under our belt. And the industry's most experienced die craftsmen working under our roof. These craftsmen, following rigid RCBS specifications developed over many years, produce more reloading dies in more calibers (over 3,300!) than any other reloading die manufacturer.

RCBS Precisioneered® Reloading Dies are for shooters who demand reloads equal to the quality of their guns. Each RCBS Die is made from case hardened steel. The inside surfaces of all RCBS Precisioneered® Dies are precision-drilled and reamed to the same exacting standards as the finest gun mechanisms.

Full-Length Sizer Dies for bottleneck cases have vents to prevent case damage caused by trapped air and for excessive lubricant. Headspace is held to minimum tolerances to avoid changing the case body length during full length sizing.

Each RCBS Die is properly hardened and hand polished. This special RCBS finishing produces a die that will withstand years and years of the abrasive type of wear caused by case sizing.

All RCBS Seater Dies have a built-in roll or taper crimper as appropriate for the particular caliber. To seat bullets without crimping, simply unscrew the die until the crimp ring no longer engages the case mouth.

Large, easy-to-adjust hex lock rings utilize hex head setscrews. Unless otherwise noted, all RCBS Precisioneered® Dies have the standard 7/8"-14 thread. Dies are packaged in stackable, plastic storage boxes specially designed to protect the dies in shipping. Includes loading data label.

Die Storage Boxes

Protects dies when not in use. Unique cradle holds from 1 to 4 dies firmly in place to prevent damage and dings.

9889	Die Storage Box – Green	\$4.95
9890	Die Storage Box – Gray	\$4.95

Gold Medal Match Dies

RCBS is proud to introduce the Gold Medal series of neck bushing rifle dies. This changeable diameter neck bushing die has been used by benchrest and long-range precision shooters for years. The Gold Medal sizing dies feature a self-centering changeable neck bushing that allows you to precisely set the amount of tension on the bullet.

Gold Medal rifle dies are available in full-length and neck sizing styles. The Gold Medal seat dies feature a micrometer adjustable, free floating and self-centering bullet seating system with a convenient bullet-loading window.

RCBS 2-Die Sets Groups A & D

2-Die Sets are for bottleneck type rifle and pistol cases, and consist of a Full-Length Sizer Die with Expander-Decapping Unit, and a Seater Die with Bullet Seater Plug.

RCBS Neck Die Sets Groups A & D

Neck Sizer Dies size only the neck of case (not the shoulder or body) just enough to snugly hold the bullet. Neck Die Sets consist of a Neck Sizer Die with Expander-Decapping Unit and a regular Seater Die with Seater Plug. Neck Sizer Dies are also available individually. Available in most calibers.



See listings on the following pages.

RCBS Small Base Die Sets Group A

Small Base Sizer Dies are usually required for reloading ammunition to be used in automatic, semi-automatic, pump, slide and some lever-action rifles. These dies size the body of cases somewhat smaller in diameter and also set the shoulder back slightly more than a Full-Length Sizer Die to ensure proper functioning in the actions of these rifles. Not recommended for ammunition used in bolt-action rifles. Small Base Set contains Small Base Sizer with Expander-Decapping Unit and Regular Seater Die with Seater Plug. Small Base Sizer Dies also available individually. Available in many calibers. See the listing on the following pages.

RCBS 3-Die Sets Groups B, C, E & Legacy

RCBS pioneered and developed the 3-Die Sets for straight-wall rifle and pistol cases. In the 3-Die Set sizing and expanding (belling) are done in separate dies. The 3-Die Set has a Sizer Die with Decapping Unit, Expander Die for expanding and belling the case mouth and a Seater Die with Roll or Taper Crimp and Bullet Seater Plug(s) for seating and crimping the bullet.



RCBS Tungsten Carbide Die Sets Groups B, C, & E

The Carbide Sizer Die eliminates the need for case lubrication and cases do not need to be cleaned before sizing. Carbide Die Sets consist of a Carbide Sizer Die with Decapping Unit, Expander Die for expanding and belling the case mouth, plus a Seater Die with Roll or Taper Crimp and Bullet Seater Plug. Carbide Sizer Dies are also available separately. Available in most popular handgun calibers and .30 M-1 Carbine. See die listings for caliber availability.

Note: Due to the length of the 30 M-1 Carbine Carbide insert, every fourth or fifth case should be lightly lubricated to eliminate sticking cases

Trim Dies

Doubles as a visual case length gauge. Run a case into the Trim Die and if the case sticks out above the top of the die, it's too long. File the case down until it is flush with the top of the die. Then, deburr the case mouth with a Deburring Tool.

Precision machined Sizer Die chamber with slightly larger neck to ensure accuracy in gauging case lengths. Headspace is held to minimum tolerances to avoid changing the length of the case. Trim Die is case hardened and hand polished. Heat treated to withstand a file bearing against the top surface without damage to die. Cases with an overall length of 1.700" and shorter requires the use of an Extended Shell Holder. See page 36 or the RCBS Special Order Catalog. Standard 7/8"-14 thread. Packed in a convenient plastic storage box.

Special Order Die Sets

If you cannot find your dies listed on the reference chart on page 30 of this catalog, please consult the RCBS Special Order catalog.

See charts on following pages for part numbers

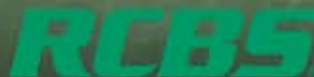

RCBS Gold Medal Match Series Dies

RCBS is proud to introduce the Gold Medal series of neck bushing rifle dies. This changeable diameter neck bushing type of die has been used by Bench Rest and Long Range Precision shooters for years.

Due to variability in neck brass thickness, RCBS standard dies size the neck below your desired diameter and then pull an expander ball through to get the proper bullet tension. The Gold Medal sizing die features a self-centering, changeable neck bushing that allows you to precisely set the amount of tension on the bullet. This reduces work hardening of the case neck brass, prolonging case life and increasing accuracy. Neck bushings are available in .001" increments from .189" to .365".

The Gold Medal rifle dies are available in Full-Length and Neck sizing styles. By removing the neck bushing, the Full Length sizing

die can be used as a "bump" die to set headspace back the desired amount.

Neck bushings are not included. Proper neck bushing size can be determined two ways. Measure the outside neck diameter of your loaded cartridge, subtract .002" to .003". This allows approximately .001" of brass spring back for correct neck tension. The other is to measure the neck wall thickness of your case, multiply by two, add the diameter of your bullet and subtract .001". RCBS suggests that you have neck bushings one to two sizes above and below your target diameter.

The Gold Medal seat dies features a micrometer adjustable, free floating and self centering bullet seating system with a convenient bullet loading window. The Gold Medal seat die can also be used on progressive presses with the exception of the .221 Rem Fireball and .22 Hornet cartridges.

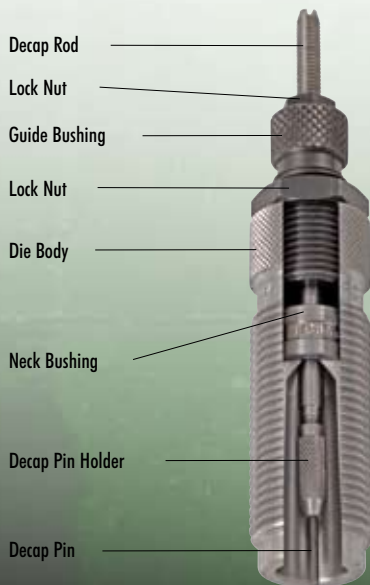

Gold Medal Match

Caliber	Full Length Bushing Die Set \$164.95	Full Length Bushing Sizer Die \$61.95	Neck Bushing Die Set \$164.95	Neck Bushing Sizer Die \$61.95	Gold Medal Seater Die \$114.95	Decap Unit \$7.95
.17 REM	17205	17234	17206	17235	17249	09882
.204 RUGER	10305	10334	10306	10335	10349	09801
.22 HORNET	10205	10234	10206	10235	10249	09802
.22 BENCH REST	29905	29934	29906	29935	29949	09802
.22 PPC	28805	28834	28806	28835	28849	09836
.22-250 REM (.22 VAR.)	10605	10634	10606	10635	10649	09802
.220 SWIFT	10705	10734	10706	10735	10749	09802
.221 REM FIREBALL	10805	10834	10806	10835	10849	09802
.222 REM	10905	10934	10906	10935	10949	09802
.223 REM (5.56MM)	11105	11134	11106	11135	11149	09802
.223 WSSM	10505	10534	10506	10535	10549	09802
.243 WSSM	11605	11634	11606	11635	11649	09805
.243 WIN	11405	11434	11406	11435	11449	09805
6MM BENCH REST	16105	16134	16106	16135	16149	09805
6MM PPC	22605	22634	22606	22635	22649	09837
6MM REM (.244 REM)	11505	11534	11506	11535	11549	09805
.25 WSSM	12405	12434	12406	12435	12449	09806
.25-06	12005	12034	12006	12035	12049	09806
6.5MM-.284 WINCHESTER	28705	28734	28706	28735	28749	09807
6.5X55 SWEDISH MAUSER	13205	13234	13206	13235	13249	09808
.270 WIN	13505	13534	13506	13535	13549	09808
.270 WIN SHORT MAG	31305	31334	31306	31335	31349	09808
7MM REM MAG	13605	13634	13606	13635	13649	09809
7MM REM SA ULTRA MAG	31105	31134	31106	31135	31149	09809
7MM REM ULTRA MAG	17805	17834	17806	17835	17849	09809
7MM STW	26605	26634	26606	26635	26649	09809
7MM T/CU	34205	34234	34206	34235	34249	09809
7MM WIN SHORT MAG	31405	31434	31406	31435	31449	09809
7MM-08 REM	13905	13934	13906	13935	13949	09809
7MM BENCH REST	34105	34134	34106	34135	34149	09809
7X57 MAUSER (7MM MAUSER)	13805	13834	13806	13835	13849	09809
7-30 WATERS	34805	34834	34806	34835	34849	09809
.308 WINCHESTER	15505	15534	15506	15535	15549	09812
.30-06 SPRINGFIELD	14805	14834	14806	14835	14849	09812
.300 WSM	30805	30834	30806	30835	30849	09812
.300 REM SA ULTRA MAG	31205	31234	31206	31235	31249	09812
.300 REM ULTRA MAG	17605	17634	17606	17635	17649	09812
.300 WBY MAG	15205	15234	15206	15235	15249	09812
.300 WIN MAG	15305	15334	15306	15335	15349	09812
.30-378 WBY MAG	29505	29534	29506	29535	29549	09812
.338 LAPUA	16605	16634	16606	16635	16649	09818

Steel Neck Bushings

\$12.95

Neck Bushing Diameter	Part Number	Neck Bushing Diameter	Part Number	Neck Bushing Diameter	Part Number	Neck Bushing Diameter	Part Number
0.185	81500	0.231	81546	0.277	81592	0.323	81638
0.186	81501	0.232	81547	0.278	81593	0.324	81639
0.187	81502	0.233	81548	0.279	81594	0.325	81640
0.188	81503	0.234	81549	0.280	81595	0.326	81641
0.189	81504	0.235	81550	0.281	81596	0.327	81642
0.190	81505	0.236	81551	0.282	81597	0.328	81643
0.191	81506	0.237	81552	0.283	81598	0.329	81644
0.192	81507	0.238	81553	0.284	81599	0.330	81645
0.193	81508	0.239	81554	0.285	81600	0.331	81646
0.194	81509	0.240	81555	0.286	81601	0.332	81647
0.195	81510	0.241	81556	0.287	81602	0.333	81648
0.196	81511	0.242	81557	0.288	81603	0.334	81649
0.197	81512	0.243	81558	0.289	81604	0.335	81650
0.198	81513	0.244	81559	0.290	81605	0.336	81651
0.199	81514	0.245	81560	0.291	81606	0.337	81652
0.200	81515	0.246	81561	0.292	81607	0.338	81653
0.201	81516	0.247	81562	0.293	81608	0.339	81654
0.202	81517	0.248	81563	0.294	81609	0.340	81655
0.203	81518	0.249	81564	0.295	81610	0.341	81656
0.204	81519	0.250	81565	0.296	81611	0.342	81657
0.205	81520	0.251	81566	0.297	81612	0.343	81658
0.206	81521	0.252	81567	0.298	81613	0.344	81659
0.207	81522	0.253	81568	0.299	81614	0.345	81660
0.208	81523	0.254	81569	0.300	81615	0.346	81661
0.209	81524	0.255	81570	0.301	81616	0.347	81662
0.210	81525	0.256	81571	0.302	81617	0.348	81663
0.211	81526	0.257	81572	0.303	81618	0.349	81664
0.212	81527	0.258	81573	0.304	81619	0.350	81665
0.213	81528	0.259	81574	0.305	81620	0.351	81666
0.214	81529	0.260	81575	0.306	81621	0.352	81667
0.215	81530	0.261	81576	0.307	81622	0.353	81668
0.216	81531	0.262	81577	0.308	81623	0.354	81669
0.217	81532	0.263	81578	0.309	81624	0.355	81670
0.218	81533	0.264	81579	0.310	81625	0.356	81671
0.219	81534	0.265	81580	0.311	81626	0.357	81672
0.220	81535	0.266	81581	0.312	81627	0.358	81673
0.221	81536	0.267	81582	0.313	81628	0.359	81674
0.222	81537	0.268	81583	0.314	81629	0.360	81675
0.223	81538	0.269	81584	0.315	81630	0.361	81676
0.224	81539	0.270	81585	0.316	81631	0.362	81677
0.225	81540	0.271	81586	0.317	81632	0.363	81678
0.226	81541	0.272	81587	0.318	81633	0.364	81679
0.227	81542	0.273	81588	0.319	81634	0.365	81680
0.228	81543	0.274	81589	0.320	81635		
0.229	81544	0.275	81590	0.321	81636		
0.230	81545	0.276	81591	0.322	81637		

Coated Neck Bushings

\$22.95

Coated Neck Bushing Diameter	Part Number	Coated Neck Bushing Diameter	Part Number	Coated Neck Bushing Diameter	Part Number	Coated Neck Bushing Diameter	Part Number
0.185	81700	0.231	81746	0.277	81792	0.323	81838
0.186	81701	0.232	81747	0.278	81793	0.324	81839
0.187	81702	0.233	81748	0.279	81794	0.325	81840
0.188	81703	0.234	81749	0.280	81795	0.326	81841
0.189	81704	0.235	81750	0.281	81796	0.327	81842
0.190	81705	0.236	81751	0.282	81797	0.328	81843
0.191	81706	0.237	81752	0.283	81798	0.329	81844
0.192	81707	0.238	81753	0.284	81799	0.330	81845
0.193	81708	0.239	81754	0.285	81800	0.331	81846
0.194	81709	0.240	81755	0.286	81801	0.332	81847
0.195	81710	0.241	81756	0.287	81802	0.333	81848
0.196	81711	0.242	81757	0.288	81803	0.334	81849
0.197	81712	0.243	81758	0.289	81804	0.335	81850
0.198	81713	0.244	81759	0.290	81805	0.336	81851
0.199	81714	0.245	81760	0.291	81806	0.337	81852
0.200	81715	0.246	81761	0.292	81807	0.338	81853
0.201	81716	0.247	81762	0.293	81808	0.339	81854
0.202	81717	0.248	81763	0.294	81809	0.340	81855
0.203	81718	0.249	81764	0.295	81810	0.341	81856
0.204	81719	0.250	81765	0.296	81811	0.342	81857
0.205	81720	0.251	81766	0.297	81812	0.343	81858
0.206	81721	0.252	81767	0.298	81813	0.344	81859
0.207	81722	0.253	81768	0.299	81814	0.345	81860
0.208	81723	0.254	81769	0.300	81815	0.346	81861
0.209	81724	0.255	81770	0.301	81816	0.347	81862
0.210	81725	0.256	81771	0.302	81817	0.348	81863
0.211	81726	0.257	81772	0.303	81818	0.349	81864
0.212	81727	0.258	81773	0.304	81819	0.350	81865
0.213	81728	0.259	81774	0.305	81820	0.351	81866
0.214	81729	0.260	81775	0.306	81821	0.352	81867
0.215	81730	0.261	81776	0.307	81822	0.353	81868
0.216	81731	0.262	81777	0.308	81823	0.354	81869
0.217	81732	0.263	81778	0.309	81824	0.355	81870
0.218	81733	0.264	81779	0.310	81825	0.356	81871
0.219	81734	0.265	81780	0.311	81826	0.357	81872
0.220	81735	0.266	81781	0.312	81827	0.358	81873
0.221	81736	0.267	81782	0.313	81828	0.359	81874
0.222	81737	0.268	81783	0.314	81829	0.360	81875
0.223	81738	0.269	81784	0.315	81830	0.361	81876
0.224	81739	0.270	81785	0.316	81831	0.362	81877
0.225	81740	0.271	81786	0.317	81832	0.363	81878
0.226	81741	0.272	81787	0.318	81833	0.364	81879
0.227	81742	0.273	81788	0.319	81834	0.365	81880
0.228	81743	0.274	81789	0.320	81835		
0.229	81744	0.275	81790	0.321	81836		
0.230	81745	0.276	81791	0.322	81837		

Competition Rifle Dies

These dies aren't for everybody. They go above and beyond our Precision Dies. If you're a competitive marksman measuring success in fractions of a millimeter, RCBS Competition Dies are for you. NOTE: Competition dies do not require neck bushings.



Competition Dies

Caliber	Competition Full-Length Die Set \$107.95	Competition Full-Length Sizer Die \$41.95	Competition Seater Die \$69.95	Competition Extended Shell Holder \$11.95	Decapping Pin \$2.95	Competition Seater Plug Assembly \$10.95	Competition Bullet Guide \$6.95
.204 RUGER	39401	39429	39438 ⁺	38260	9608	*	38201
.22 HORNET	38301	38329	38338 ⁺	38262	—	*	38202
.222 REM	37001	37029	37038 ⁺	38260	9608	*	38202
.223 REM	37201	37229	37238 ⁺	38260	9608	*	38202
.22-250 REM	37101	37129	37138 ⁺	38253	9608	*	38202
.243 WIN	37301	37329	37338 ⁺	38253	9608	*	38205
.25-06	39501	39529	39538	—	9609	*	38206
6.5MMX55 SWEDISH MAUSER	38401	38429	38438 ⁺	38252	9609	*	38207
.270 WIN	37501	37529	37538	—	9609	*	38208
7MM-08 REM	37401	37429	37438 ⁺	38253	9609	*	38209
7MM REM MAG	37601	37629	37638	—	9609	*	38209
7MMX64 BRENNERKE	38501	38529	38538	—	9609	*	38209
7.5MMX55 SCHMIDT-RUBIN	38601	38629	38638	—	9609	*	38212
.30-06 SPRINGFIELD	37701	37729	37738	—	9609	*	38212
.308 WIN	37801	37829	37838 ⁺	38253	9609	*	38212
8MMX57 MAUSER	38701	38729	38738	—	9609	*	38214

⁺ Competition Extended Shell Holder included

* Available only by calling RCBS Customer Service



Competition Rifle Two Die Sets

FEATURES & BENEFITS

- Full-length sizer with a raised expander ball allowing extra leverage for smooth, effortless neck expansion
- Maximum concentricity between die neck and body
- Seater die with micrometer for super accurate bullet seating depth in increments of 0.001"
- Bullet inserts through a side window instead of bottom of die
- Special bullet-seating guide ensures correct bullet alignment before and after seating.
- Extended shell holder for shorter cartridges
- Black oxide finish
- Not for use with progressive reloading presses

RELOADING DIES

Group A Caliber	Full Length Die Set \$35.95	Full Length Sizer Die \$29.95	Neck Die Set \$38.95 \$54.95*	Neck Sizer Die \$38.95 \$38.95*	Small Base Die Set \$38.95 \$54.95*	Small Base Sizer Die \$31.95 \$38.95*	Seater Die \$24.95	Exp-Decap Unit \$7.95	Trim Die \$34.95
.17 REM	17201	17229	17202	17230	—	—	17238	9882	17265*
.204 RUGER	10301	—	10302	10330	—	—	—	9801	—
.218 BEE	10001	10029	10002*	10030	—	—	10038	9802	10065*
.22 HORNET	10201	10229	10202	10230	—	—	10238	9802	10265*
.22-250 REM (.22 VAR.)	10601	10629	10602	10630	10603*	10631*	10638	9802	10665
.220 SWIFT	10701	10729	10702	10730	—	—	10738	9802	10765
.221 REM FIREBALL	10801	10829	10802	10830	—	—	10838	9802	10865*
.222 REM	10901	10929	10902	10930	+	+	10938	9802	10965
.222 REM MAG	11001	11029	11002	11030	—	—	11038	9802	11065*
.223 REM (5.56MM)	11101	11129	11102	11130	11103	11131	11138	9802	11165
.223 WSSM	10501	—	10502	10530	—	—	—	9802	—
5.7MMX28 (FN)	11701	11729	—	—	11703	11731	11738	9802	—
.240 WBY MAG	33201	33229	33202	33230	—	—	33238	9805	33265*
.243 WIN	11401	11429	11402	11430	11403	11431	11438	9805	11465
.243 WSSM	11601	—	11602	11630	—	—	—	9805	—
6MM REM (.244 REM)	11501	11529	11502	11530	11503*	11531*	11538	9805	11565
6MM PPC	22601	22629	22602	22630	—	—	22638	9837	22665*
.25-06	12001	12029	12002	12030	+	+	12038	9806	12065
.25 WSSM	12401	12429	12402	12430	—	—	12438	9806	—
.25-20 WIN	11801	11829	11802	11830	—	—	11838	9806	11865*
.25-35 WIN	12101	12129	12102	12130	—	—	12138	9806	12165*
.250 SAV (.250-3000 SAVAGE)	12201	12229	—	—	+	+	12238	9806	12265*
.257 ROBERTS	12501	12529	12502*	12530*	—	—	12538	9806	12565*
.257 WBY MAG	12601	12629	12602*	12630*	—	—	12638	9806	12665*
.260 REM	12801	12829	12802	12830	—	—	12838	9807	12865*
.264 WIN MAG	12701	12729	12702*	12730*	—	—	12738	9807	12765*
6.5X55 SWEDISH MAUSER	13201	13229	13202	13230	—	—	13238	9807	13265*
6.8 REMINGTON SPC	13301	13329	—	—	13303	13331	13338	9808	—
.270 WBY MAG	13401	13429	13402*	13430*	—	—	13438	9808	13465*
.270 WIN	13501	13529	13502	13530	13503	13531	13538	9808	13565
.270 WIN SHORT MAG	31301	31329	31302*	31330*	31303	31331	31338	9808	31365*
.280 REM (7MM EXP REM)	14001	14029	14002*	14030*	14003*	14031*	14038	9809	14065*
.284 WIN	14101	14129	14102	14130	+	+	14138	9809	14165*
7MM REM MAG	13601	13629	13602	13630	13603	13631	13638	9809	13665
7MM REM SA ULTRA MAG	31101	31129	31102*	31130*	—	—	31138	9809	31165*
7MM REM ULTRA MAG	17801	17829	17802	17830	—	—	17838	9809	17865*
7MM STW	26601	26629	26602	26630	—	—	26638	9809	26665*
7MM T/CU	34201	34229	34202	34230	—	—	34238	9811	34265*
7MM WBY MAG	13701	13729	13702	13730	—	—	13738	9809	13765*
7MM WIN SHORT MAG	31401	31429	31402*	31430**	31403	31431	31438	9809	31465*
7MM-08 REM	13901	13929	13902	13930	+	+	13938	9809	13965*
7X57 MAUSER (7MM MAUSER)	13801	13829	13802	13830	—	—	13838	9809	13865
7MMX64 BREN	34001	34029	34002*	34030*	—	—	34038	9809	34065*
7-30 WATERS	34801	34829	34802*	34830*	—	—	34838	9809	34865*
7.5MM SCH-RUBIN (1911)	33501	33529	33502	33530	—	—	33538	9812	33565*
7.62X54R RUSS	29001	29029	29002*	29030*	—	—	29038	***	29065*
7.62MMX39-.308/311	35001	35029	—	—	—	—	35038	**	35065*
7.65MMX53 BEL MSR	14301	14329	14302	14330	—	—	14338	9814	14365*
7.7MMX58 JAP ARI	14401	14429	14402	14430	—	—	14438	9814	14465*
.30 LUGER (7.65MM LUGER)	25001	25029	25002	25030	—	—	25038	9813	25065*
.30-06 SPRINGFIELD	14801	14829	14802	14830	14803	14831	14838	9812	14865
.30-30 WIN	14601	14629	14602*	14630*	—	—	14638	9812	14665
.30-378 WBY MAG	29501	29529	29502	29530	—	—	29538	9812	29565*
.30-40 Krag	14701	14729	—	—	—	—	14738	9812	14765*
.300 H&H MAG	15001	15029	15002	15030	—	—	15038	9812	15065*
.300 REM SA ULTRA MAG	31201	31229	31202*	31230*	—	—	31238	9812	31265*
.300 REM ULTRA MAG	17601	17629	17602	17630	—	—	17638	9812	17665*
.300 SAV	15101	15129	—	—	15103*	15131*	15138	9812	15165*
.300 WBY MAG	15201	15229	15202	15230	—	—	15238	9812	15265*
.300 WIN MAG	15301	15329	15302	15330	15303	15331	15338	9812	15365
.300 WIN SHORT MAG	30801	30829	30802*	30830*	30803	30831	30838	9812	30865*
.303 BRIT	15401	15429	15402	15430	—	—	15438	9814	15465*
.308 WIN / .307 WIN	15501	15529	15502	15530	15503	15531	15538	9812	15565
8MMX57 MAUSER (8MM MSR)	15901	15929	15902	15930	—	—	15938	9817	15965
8MM REM MAG	16001	16029	16002	16030	—	—	16038	9817	16065*
.32 WIN SPEC	15701	15729	—	—	—	—	15738	9816	15765*
.32 WIN SPEC	15701	15729	—	—	—	—	15738	9816	15765*
.325 WIN SHORT MAG	31601	31629	31602	31630	31603	31631	31638	9817	16665*
.338 FEDERAL	17301	17329	17302	17330	—	—	17338	9828	—
.338 REM ULTRA MAG	17701	17729	17702*	17730*	—	—	17738	9818	17765*
.338 WIN MAG	16301	16329	16302	16330	16303*	16331*	16338	9818	16365*
.338-378 WBY MAG	16801	16829	16802	16830	—	—	16838	9818	16865*
.340 WBY MAG	30601	30629	30602	30630	—	—	30638	9818	30665*
.35 REM	16501	16529	—	—	+	+	16538	9820	16565*
.35 WHELEN	30701	30729	—	—	—	—	30738	9823	30765*
.357 SIG	23101	23129	—	—	—	—	23138	9834	23165*
.358 WIN/.356 WIN	32701	32729	—	—	—	—	32738	9823	32765*
9.3MMX62 MAUSER	34501	34529	34502	34530	—	—	34538	9821	34565*
.375 H&H MAG	16901	16929	16902*	16930*	—	—	16938	9822	16965*
.375 REM ULTRA MAG	30901	30929	30902*	30930*	—	—	30938	9822	30965*

*If not in stock, please allow 4-6 weeks for delivery. **A .30 caliber Expander Ball is also included with Die Set and Sizer Die. ***A .310 caliber Expander Ball is also included with Die Set and Sizer Die. + See the RCBS Special Catalog for this item.



Group B											
Caliber	3-Die Carbide Roll Crimp Set \$51.95	3-Die Carbide Taper Crimp Set \$51.95	3-Die Roll Crimp Set \$38.95	3-Die Taper Crimp Set \$38.95	Carbide Sizer Die \$36.95	Steel Sizer Die \$20.95	Expander Die \$14.95	Roll Crimp Seater Die \$19.95	Taper Crimp Seater Die \$19.95	Decap Unit \$7.95	Trim Die \$34.95
.32 AUTO (1)	—	20015	—	—	20037	—	20053	—	20062	9622	20065*
.357 MAG/.357 REM MAX/.38 SPEC	18212	18215	—	—	18237	18332	18353	18342	18262	9622	18265/18365
9MM LUGER/9X21/356 TSW/9X23 WIN/9X18 ULTRA	—	20515	—	—	20537	—	20552	20538	20562	9622	20565*/22365*
.380 AUTO	—	20415	—	—	20437	—	20449	—	20462	9622	20465*
.40 S&W/10MM AUTO	—	22115	—	—	22137	—	22153	—	22162	9622	22165*/21665*
.41 MAG	18512	—	—	—	18537	—	18553	18542	—	9622	18565*
.44 MAG/.44 SPEC	18612	—	18608	—	18637	18732	18753	18742	18662	9622	18665/18765*
.44-40 WIN (3)	—	—	18805	—	—	18832	18853	18839	—	9622	18865*
44-40 WIN JACKETED (4)	—	—	18806	—	—	18832	—	18840	—	9622	18865*
.45 AUTO(ACP)/AUTO RIM/GLOCK ACT. PISTOL	—	18915	—	—	18937	—	18953	18942	18962	9622	18965
.45 COLT	19112	—	19108	—	19137	19132	19153	19142	—	9622	19165*
.460 SMITH & WESSON	24212	—	—	—	24237	—	24253	24238	—	9622	—
.454 CASULL	23212	—	—	—	23237	—	23253	23242	—	9622	23265*
.480 RUGER/.475 LINEBAUGH 1.400"	35212	—	35208	—	35237	35232	35253	35238	—	9622	35265*
.50 ACTION EXPRESS	—	—	—	22210	—	22232	22253	—	22262	9622	22265*
.500 S&W	23812	—	23808	—	23837	23832	23853	23838	—	9622	—

*May not be available from stock. 1: For use with .311" bullets. 2: For use with .314" bullets . 3: Regular Seater Die for all lead and jacketed bullets from Hornady, Sierra and Speer. 4: Jacketed Seater Die for Remington bullets only.

Group C											
Caliber	3-Die Carbide Taper Crimp Set \$71.95	3-Die Roll Crimp Set \$46.95	3-Die Taper Crimp Set \$46.95	Carbide Sizer Die \$53.95	Steel Sizer Die \$24.95	Expander Die \$17.95	Roll Crimp Seater Die \$22.95	Taper Crimp Seater Die \$22.95	Decap Unit \$7.95	Trim Die \$34.95	
.30 M-1 CARBINE	18015	—	18010	18037	18032	18053	—	18062	9622	18065*	
.375 WIN	—	20604	—	—	20633	20658	20638	—	9619	20665*	
.444 MARLIN	—	20704	—	—	20733	20758	20738	—	9619	20765*	
.45-70 US GOV'T	—	20904	—	—	20933	20955	20938	—	9619	20965*	
.450 MARLIN	—	35504	—	—	35533	35558	35538	—	9619	35565*	
.458 WIN MAG	—	20804	—	—	20833	20858	20838	—	9619	20865*	
.458 LOTT	—	24104	—	—	24133	20858	24138	—	9619	24165*	

*May not be available from stock.

Group D								
Caliber	Full-Length Die Set \$62.95	Full-Length Sizer Die \$43.95	Neck Die Set \$73.95	Neck Sizer Die \$53.95	Seater Die \$34.95	Exp-Decap Unit \$7.95	Trim Die \$47.95	
.22 K-HORNET	26201	26229	26202*	26230*	26238	9802	26265*	
.22 REM JET	10401	10429	10402*	10430*	10438	9800	10465*	
.22 SAVAGE HI POWER	33801	33829	33802*	33830*	33838	9803	33865*	
5.6MMX50 RIMMED	26301	26329	26302*	26330*	26338	9802	26365*	
.257 ROBERTS IMP 40	32201	32229	32202*	32230*	32238	9806	32265*	
6.5 REM MAG.	33401	33429	—	—	33438	9807	—	
6.5MM-06	27801	27829	27802*	27830*	27838	9807	27865*	
6.5MM-284 WIN	28701	28729	28702*	28730*	28738	9807	—	
6.5MMX54 MANNLICHER-SCHOEN.	27701	27729	27702*	27730*	27738	9807	27765*	
6.5MMX57 MAUSER	32801	32829	32802*	32830*	32838	9807	32865*	
6.5MMX68S	27901	27929	27902*	27930*	27938	9807	27965*	
7MM B R REM	34101	34129	34102*	34130*	34138	9809	34165*	
7MMX65 RIMMED	26701	26729	26702*	26730*	26738	9809	26765*	
.30 MAUSER (7.63MM MAUSER)	25101	25129	25102*	25130*	25138	9813	25165*	
.30 REM	29201	29229	29202*	29230*	29238	9812	29265*	
.30-338 WIN MAG	29401	29429	29402*	29430*	29438	9812	29465*	
.300 H&H MAG	15001	15029	15002*	15030*	15038	9812	15065*	
.308 NORMA MAG	15601	15629	15602*	15630*	15638	9812	15665*	
7.5MMX54 FRENCH MAS	29101	29129	29102*	29130*	29138	9832	29165*	
.32-40 WIN	32501	32529	32502*	32530*	32538	9816	32565*	
8MM-06	32601	32629	32602*	32630*	32638	9817	32665*	
8MMX68S MAGNUM	34401	34429	34402*	34430*	34438	9817	34465*	
.338-06	16701	16729	16702*	16730*	16738	9828	16765*	
.348 WIN	33601	33629	—	—	33638	9819	33665*	
.350 REM MAG	33701	33729	33702*	33730*	33738	9820	33765*	
9.3MMX74 RIMMED	34601	34629	34602*	34630*	34638	9821	34665*	
.376 STEYR	17901	17929	17902*	17930*	17938	9822	17965*	
.378 WBY MAG	33001	33029	33002*	33030*	33038	9822	33065*	
.400 CORBON	17501	17529	—	—	17538	9835	17565*	
.416 REM MAG	22701	22729	22702*	22730*	22738	9827	22765*	
.416 RIGBY	22801	22829	22802*	22830*	22838	9825	22865*	
.460 WBY MAG	33101	33129	33102*	33130*	33138	9826	33165*	

*May not be available from stock. **A Small Base Die Set and a Small Base Sizer Die are also available for this caliber. See RCBS Special Order Catalog.



Group E	3-Die Carbide Taper Crimp Set	3-Die Carbide Roll Crimp Set	3-Die Roll Crimp Set	Carbide Sizer Die	Steel Sizer Die	Expander Die	Roll Crimp Seater Die	Taper Crimp Seater Die	Decap Unit	Trim Die
	\$81.95	\$81.95	\$53.95	\$53.95	\$39.95	\$24.95	\$31.95	\$31.95	\$7.95	\$47.95
.25 AUTO (.25 ACP)	21015	—	—	21037	—	21049	—	21062	9621	21065*
.32 S&W LONG/.32 H&R MAG	21415	21412	—	21437	—	21453	21442	21462	9622	20165/21365*
.32-20 WIN	—	—	18105	—	18132	18153	18139	—	9622	18165*
9MM FAR	—	—	23210**	—	23232	23252	—	23262	9622	—
9MM MAKAROV	23015	—	—	23037	—	23053	—	23062	9622	23065*
.38 COLT SUPER AUTO/ACP	20215	—	—	20237	—	20252	—	20262	9622	20265*
.38-40 WIN (1)	—	—	35605	—	35632	35653	35639	—	9622	35665*

*May not be available from stock. †For use with lead bullets only
**9mm FAR is a steel sizing die with taper crimp

Legacy Series Dies

With new calibers and rifles introduced every year, it is a wonder that black powder cartridges are still around! The Legacy series of dies supports these legendary metallic black powder cartridges and the enthusiasts that are shooting original or reproduction black powder rifles.

Legacy Series Dies

Caliber	3-Die Roll Crimp Set	Steel Sizer Die	Expander Die	Roll Crimp Seater Die	Decap Unit	Trim Die
	\$51.95	\$36.95	\$19.95	\$23.95	\$7.95	\$45.95
.38-55 WIN & BAL	36504	36533	36555	36538	9619	36565*
.40-65 SHILOH SHARPS (.408 BORE)	23304	23333	23358	23338	9619	23365*
.40-70-2½" SHARPS STRAIGHT	19204	19233	19258	19238	9619	19265*
.405 WIN	23608	23633	23658	23638	9619	23665*
.45-90-2.4" SHARPS STRAIGHT	19304	19333	19358	19338	9619	19365*
.45-100-2.6" SHARPS STRAIGHT	19404	19433	19458	19438	9619	19465*
.45-110-2½" SHARPS STRAIGHT	19504	19533	19558	19538	9619	19565*
.45-120-3¼" SHARPS STRAIGHT	19604	19633	19658	19638	9619	19665*
.50-70 GOV'T	36804	36833	36858	36838	9619	36865*
.50-90-2½" SHARPS STRAIGHT	19704	19733	19758	19738	9619	19765*

Alternate Seater Plugs (Special Application)

These through-the-top seater plugs (1/2" - 20 thread) are available separately and manufactured to fit bullets shown in the chart below. They are not furnished with the die sets or seater dies. Seater plugs with 1/4" - 28 thread design, are for use with older RCBS dies and can be made on a special order basis. Call or write RCBS for information.

Alternate Seater Plugs—1/2"-20	
Caliber	\$5.95
25 Cal. 35 gr. Gold Dot	90071
32 Cal. Wadcutter	90014
32 Cal. 60 gr. Gold Dot	90072
357 SIG 125 gr. Gold Dot	90073
357 Cal 180 gr. Silhouette	90019
38 Cal. 125 gr. Gold Dot	90065
38 Cal. 158 gr. Gold Dot	90066
9mm Cal. 90 gr. Gold Dot	90060
9mm Cal. 115 gr. Gold Dot	90061
9mm Cal. 124 gr. Gold Dot	90062
9mm Cal. 147 gr. Gold Dot	90063
9mm Makarov 95 gr. Conical	90016
9mm Makarov 90 gr. Gold Dot	90064
40/10mm 155 gr. Gold Dot	90067
40/10mm 165 gr. Gold Dot	90074
40/10mm 180 gr. Gold Dot	90068
10mm Round Nose	90039
40-Cal 400 Black Powder	90042
44 Cal. 240 gr. Silhouette	90031
44 Cal. 270 gr. Gold Dot	90075
.44/.45 SWC	90033
45 Cal. 185 gr. Gold Dot	90069
45 Cal. 200 gr. Barnex XPB	90034
45 Cal. 230 gr. Gold Dot	90070
45 Cal. 500 gr. Black Powder Silhouette	90080

Alternate Seater Plugs—1/4"-28	
Caliber	\$5.95
.50 Cal. 325 gr. BarnesX	9663
7mm Silhouette	9696
.30 Cal Silhouette	9697

Replacement Parts

Expander-Decapping Rods, Decapping Rods, Expander Balls and Decapping Pin Holders are no longer available separately. If any of these fail, order a replacement Expander-Decapping Unit or Decapping Unit as shown in the tables.

Replacement Decapping Pins

With the few exceptions listed below, all RCBS "Precision," Reloader Special, X and Cowboy Sizer Dies require a #90164 headed Decapping Pin — one size fits all calibers. Order straight Decapping Pins for Competition and older "Precision" Sizer Dies.

Pow'r Punch Decap Assembly for use with pistol calibers in progressive presses.

Decapping Pins - 5-Pack	
Caliber	\$2.95
6mm PPC	09608
7mm Thompson Center Ugalde	09609
35 Whelen	09609
357 SIG	09608
358 Winchester/356 Winchester	09609
416 Remington Magnum	09609

Decapping Pins - 5-Pack	
Size/Type/Caliber	\$2.95
Universal - Headed 22 thru 45 caliber	90164
Small - Straight 22 thru 25 caliber	09608
Large - Straight 6.5mm thru 45 caliber	09609

Important: Expander-Decapping Units, Decapping Units and all Decapping Pins are available through RCBS Distributors and Dealers. All other replacement parts should be ordered from RCBS Customer Service.



Cowboy Dies Cowboy Action Shooting

Cowboy Action Shooting is just about the fastest growing shooting sport around. Not only are the usual competition traits of speed and accuracy required, but the

shooter must recreate the spirit of the 1880's. Guns, ammo and costumes must fit the period.

Jacketed bullets aren't permitted by Cowboy Action Shooting rules. Making ammo that fits the Old West image means loading lead bullets. It also means that the bullets must be designed to work properly in lever-action rifles and single-action revolvers. Loading dies must be optimized for lead bullets. That's where the RCBS Cowboy Dies and Bullet Moulds come in.

Our Cowboy Dies are built to slightly different dimensions than our regular dies to allow optimum sizing, expanding, seating and crimping needed to load great lead bullet ammo. In keeping with the spirit of

the game, Cowboy Dies even look different.

Instead of the satin steel finish on other RCBS dies, our Cowboy Dies go through a heat treatment that gives a more authentic appearance. Handsome brass lock rings and packaging reflecting the period, complete the picture. New Cowboy Moulds produce bullets that are profiled to give smooth feeding and follow the design of a century ago. Beveled crimping grooves set the proper cartridge length and improve consistency, and generous lube grooves hold enough lubricant even for black powder loads. Whether you're a serious cowboy competitor or just having fun, RCBS Cowboy products will load the ammo you need.

Cowboy Dies & Parts

Caliber	3-Die Full-Length Set \$56.95	3-Die Roll Crimp Set \$56.95	3-Die Carbide Roll Crimp Set \$59.95	Steel Sizer Die \$36.95	Carbide Sizer Die \$48.95	Expander Die \$24.95	Expander Assembly \$5.95	Roll Crimp Seater Die \$24.95	Seater Plug \$5.95	Decap Unit \$7.95
.25-20 WIN	11850	—	—	11856	—	11857	9901	11858	90081	9628
.30-30 WIN	14650	—	—	14656	—	14657	9902	14658	90082	9628
.32 S&W LONG/.32 S&W	—	—	21451	—	21456	21457	9903/9917	21458	90083	9628
.32 WIN SPEC	15750	—	—	15756	—	15757	9904	15758	90084	9628
.32-20 WIN	—	18151	—	18156	—	18157	9905	18158	90092	9628
.32-40 WIN	32550	—	—	32556	—	32557	9904	32558	90084	9628
.357 MAG/.38 SPEC	—	—	18251	—	18256	18257	9906	18258	90085	9628
.38 S&W	—	20351	—	20356	—	20357	9906/9916	20358	90086	9628
.38-40 WIN	—	35651	—	35656	—	35657	9907	35658	90087	9628
.38-55 WIN	—	36551	—	36556	—	36557	9908/9915	36558	90088	9628
.40-65 WIN .410" BORE	—	36651	—	36656	—	36657	9909	36658	90087	9628
.44 S&W RUSS/44 SPEC	—	—	18651	—	18656	18657	9910	18658	90089	9628
.44-40 WIN	—	18851	—	18856	—	18857	9911	18858	90089	9628
.45 S&W SCHO/45 COLT	—	—	19151	—	19156	19157	9912/9913	19158	90090	9628
.45-70 US GOVT	—	20951	—	20956	—	20957	9914	20958	90091	9628

RCBS Cowboy Dies

FEATURES & BENEFITS

- Designed for use with lever-action rifles and single-action revolvers
- Brass lock rings and heat treatment give a historic look
- Made to proper dimensions for RCBS Lead Bullets
- Designed for the soft lead bullet shooter
- See RCBS Cowboy Moulds on page 45

.50 BMG Dies

The dies are precision machined by the same craftsmen that produce our Precisioneered® Reloading Dies. The Full Length Sizer Die is drilled and reamed to the dimensions developed over the years. Then each die is hand polished, heat treated and then repolished. These massive dies are designed for use with the AmmoMaster-2 or the AmmoMaster Single Stage Press with the .50 BMG Conversion Kit installed. All Dies listed here are manufactured with 1-1/2"-12 thread. Full Length Die Set includes Full Length Sizer Die with Expander-Decapping Unit and Seater Die with Bullet Seater Plug. Trim Die is case hardened to prevent damage to the die when filing cases to length. Neck Sizer Die sizes only the neck, not the shoulder and body.

Note: .50 BMG Dies with the 1-3/8"-12 thread for use with the RCBS Big Max Press are listed in the RCBS Special Order Catalog

.50 BMG Dies

Caliber	Full-Length Die Set \$297.95	Neck Sizer Die \$182.95	Trim Die \$146.95	Lock Ring \$8.95	Decap Assy \$15.95	Decap Pin \$5.95
50 BMG1- 1 1/2	30001	30030	30065	9629	9838	9602

Seat Plug Assemblies - .50 BMG

Caliber		\$6.95
Seat Plug Assy .50 BMG A-Max (5/16-24)	09642	
Seat Plug Assy .50 BMG Speer (5/16-24)	09649	
Seat Plug Assy .50 BMG A-Max (5/8-18)	90093	



RELOADING DIES

X Die Chart			
Caliber	X Full-Length Die Set \$50.95	X Full-Length Sizer Die \$42.95	X Mandrel Assembly \$9.95
.204 RUGER	10312	10309	10314
.22 HORNET	38312	38309	38314
.22-250 REM	37112	37009	37114
.220 SWIFT	38812	38809	38814
.222 REM	37012	37209	37014
.223 REM	37212	37109	37214
.223 REM SMALL BASE	38862*	38859*	37214
.223 WSSM	10512	10509	10514
.243 WIN	37312	37309	37314
.243 WSSM	11612	11609	11614
.25 WSSM	12412	12409	12414
.25-06	38962	38959	38964
.260 REM	39012	39009	39014
6.5MMX55 SWEDISH MAUSER	38412	38409	38414
.270 WIN SHORT MAG	31312	31309	31314
.270 WIN	37512	37509	37514
.280 REM	39062	39059	39064
7MM REM MAG	37612	37609	37614
7MM REM SA ULTRA MAG	31112	31109	31114
7MM REM ULTRA MAG	17812	17809	17814
7MM STW	39112	39109	39114
7MM WIN SHORT MAG	31412	31409	31414
7MM-08 REM	37412	37409	37414
.30-06 SPGFLD	37712	37709	37714
.30-06 SPGFLD SMALL BASE	39162*	39159*	37714
.30-30 WIN	37912	37909	37914
.300 REM SA ULTRA MAG	31212	31209	31214
.300 REM ULTRA MAG	17612	17609	17614
.300 WBY MAG	39212	39209	39214
.300 WIN MAG	38912	38909	38914
.300 WIN SHORT MAG	30812	30809	30814
.303 BRITISH	39362	39359	39364
.308 WIN	37812	37809	37814
.308 WIN SMALL BASE	39262*	39259*	37814
8MMX57 MAUSER	38712	38709	38714
.325 WIN SHORT MAG	31612	31609	31614
.338 REM ULTRA MAG	17712	17709	17714
.338 WIN MAG	39312	39309	39314
.375 REM ULTRA MAG	30912	30909	30914

*For automatic, semi-automatic, pump, slide and some lever-action rifles only



X-DIES

The RCBS X-DIE has a unique design feature that controls case growth during sizing. After an initial trim to standard case lengths, the X-DIE allows repeated full-length resizing without the case length exceeding the industry maximums. Routine trimming after each sizing is eliminated. A precision mandrel in the X-DIE limits growth of the case without shortening it or causing metal build-up in the neck. The X-DIE is available in 36 rifle cartridges and replaces the standard full-length sizing die.

X-Dies®

Trim the case once - never trim again! The X-Sizer Die looks like a regular Full Length Sizer Die. Inside, the die features a specially designed mandrel with an expander ball and decapping pin attached. The mandrel is what the X-Die is all about. The patented X-Sizer Die eliminates the need for repeated trimming after an initial trim of .020" off the maximum case length to standardize the case. The X-Die doesn't shorten the length of the case: the mandrel reduces the growth rate as the case grows as a result of the case mouth-contacting the mandrel during sizing. Because of an extremely close tolerance between the mandrel and die neck wall, the neck wall of the case does not thicken as the case length is pushed back. Cases repeatedly sized in the X-Die will initially grow a few thousandths of an inch, then stabilize below the maximum case length with no discernable loss of accuracy or case life.

Available in most popular bottleneck calibers as shown in the chart.
Standard 7/8"-14 thread. U.S. Patent # 5635661

If you are just starting to reload any of the calibers listed, order the X-Full Length Die Set containing the X-Sizer Die and Standard Seater Die. If you already own a regular set of dies for the chosen caliber, order only the X-Full Length Sizer Die, as you won't need to purchase another Seater Die.

For more information about RCBS products and reloading guides, to ask questions, or to find the RCBS dealer nearest you, visit us at:

www.rcbs.com

RCBS®

SPECIAL ORDER

RCBS Precisioneered® Dies begin and end with PEOPLE! Experienced people. Patient people. And rarest of all in today's hurry-up rush-it-out world, people who still take great pleasure and pride in doing a better job than the next guy. From machine operators to hand finishers, each is responsible for providing you with the world's finest dies – RCBS Precisioneered® Dies.

RCBS special order dies and case forming dies, like all RCBS dies, are produced in our own plant by the most experienced die craftsmen in the industry. The dies are machined, hardened, hand-finished and hand-inspected for precision and quality. All products in this category carry the RCBS lifetime warranty.

With the exception of the Group X Dies, all reloading and case forming dies are manufactured with the standard 7/8"-14 thread, and may be used with most reloading presses. Group X Dies are manufactured with a 1"-14 thread for use only in the RCBS AmmoMaster-Single, Big Max, Rock Chucker, Rock Chucker Supreme, Reloader Special-3 and 5, Model A-2, or Model A-3 presses. When ordering Group X dies you must specify RCBS press model so the proper adapter bushing can be supplied.

All items in this catalog may be ordered through your RCBS Dealer. Or, you may order direct from the RCBS factory. All factory orders must be paid in advance of shipment and are not subject to cancellation or return for credit. Payment may be made by check or money order in U.S. funds or your order maybe changed to your Visa or MasterCard account. Due to bank collection fees, international orders (except Canada) must be paid by MasterCard or Visa only. Sorry, no C.O.D. shipments. Be sure to include your daytime phone number in case we need to contact you concerning your order.

Shipping and handling: \$0.01 - \$100.00 = \$6.50. \$100.01 - \$200.00 = \$10.00. \$200.01 and up = \$15.00 (Domestic U.S. only). UPS Next Day Air and 2nd Day Air are available. Call for more information. International consumer direct orders will be shipped via UPS or FedEx International ONLY.



Special Order Reloading Dies are assigned to pricing groups depending on the number of dies per set, special components, and time required to manufacture. If the desired caliber is out of stock, please allow 30 - 45 days for delivery.

Custom Reloading & Case Forming Dies

RCBS no longer produces unique, one-of-a-kind, custom dies or custom bullet moulds. RCBS still offers approximately 650 special order die sets and 350 case form sets in this special order catalog. RCBS offers more than 1,000 other calibers, reloading die sets and case form sets which are not listed in this catalog. For more information, email stan.mayle@atk.com or call 1-800-533-5000, ext. 195.

SHELL HOLDERS

Shell Holder Chart - \$6.95

09201	Number 1:	.375 Holland & Holland Magnum	09221	Number 21:	.303 Savage
.218 Bee		.416 Remington Magnum	09222	Number 22:	.450 Marlin
.25-20 Winchester		.450 Marlin			11mm Mauser
.32-20 Winchester		.458 Winchester Magnum			43 Spanish
09202	Number 2:	.458 Lott	09223	Number 23:	.32 Harrington & Richardson Mag
.22 Savage High Power	09205	Number 5:	09224	Number 24:	.32 Smith & Wesson Long
.25-35 Winchester	.348 Winchester		09225	Number 25:	.405 Winchester
6.5mm x 55 Swedish Mauser	09206	Number 6:	09226	Number 26:	.357 Magnum
7-30 Waters	.22 Remington Jet		09227	Number 27:	8mm Nambu
.307 Winchester	5.6mm x 50 Rimmed		09228	Number 28:	7mm x 65 Rimmed
.30-30 Winchester	.357 Magnum		09229	Number 29:	.357 SIG
7.5mm x 54 French MAS	.357 Remington Maximum		09230	Number 30:	.40 S & W
7.5mm x 55 Schmidt-Rubin	.38 Smith & Wesson		09231	Number 31:	10mm Auto
.32 Winchester Special	.38 Special		09232	Number 32:	99228
.32-40 Winchester	09207	Number 7:	09233	Number 33:	.444 Marlin
.356 Winchester	.30-40 Krag		09234	Number 34:	.444 Marlin
.375 Winchester	.303 British		09235	Number 35:	.25 Automatic (.25 ACP)
.38-55 Winchester & Ballard	09208	Number 8:	09236	Number 36:	.25 Automatic (.25 ACP)
09203	Number 3:	.45 Auto Rim	09237	Number 37:	22 PPC
.22 Bench Rest Remington	09209	Number 9:	09238	Number 38:	6mm PPC
.22-250 Remington (.22 Varm)	6.5mm x 54 Mannlicher-Schoenauer		09239	Number 39:	7.62mm x 39
.240 Weatherby Magnum	.35 Remington		09240	Number 40:	.50 Action Express
.243 Winchester	09210	Number 10:	09241	Number 41:	09234
6mm Bench Rest Remington	.17 Remington		09242	Number 42:	6.5mm x 68S
6mm Remington (.244 Remington)	.204 Ruger		09243	Number 43:	8mm x 68S Magnum
.25-06	.221 Remington Fire Ball		09244	Number 44:	.45 Schofield
.250 Savage (.250-3000 Savage)	.222 Remington		09245	Number 45:	99235
.257 Roberts	.222 Remington Magnum		09246	Number 46:	.38-40 Winchester
.257 Roberts Improved (40°) *	.223 Remington (5.56mm)		09247	Number 47:	.44-40 Winchester
.260 Remington	7mm Thompson/Center Ugalde		09248	Number 48:	99236
6.5mm-06	.380 Auto Pistol		09249	Number 49:	.45 Winchester Magnum
6.5-284 Winchester	09211	Number 11:	09250	Number 50:	99237
6.5mm x 57	.220 Swift		09251	Number 51:	.416 Rigby
.270 Winchester	09212	Number 12:	09252	Number 52:	99238
.280 Remington (7mm Exp. Rem.)	.22 Hornet		09253	Number 53:	7mm Remington Short Action Ultra
.284 Winchester	.22 K-Hornet		09254	Number 54:	Magnum
7mm Bench Rest Remington	09213	Number 13:	09255	Number 55:	7mm Remington Ultra Magnum
7mm-08 Remington	7.62mm x 54R Russian		09256	Number 56:	.300 Remington Short Action Ultra
7mm x 57 Mauser (7mm Mauser)	09214	Number 14:	09257	Number 57:	Magnum
7mm x 64 Brenneke	.30-378 Weatherby Magnum		09258	Number 58:	.300 Remington Ultra Magnum
.30-06 Springfield	.338 Lapua		09259	Number 59:	.338 Remington Ultra Magnum
.300 Savage	.338-378 Weatherby Magnum		09260	Number 60:	.455 Webley
.308 Winchester	.378 Weatherby Magnum		09261	Number 61:	99239
7.65mm x 53 Mauser (Belgian)	.40-65 Shiloh-Sharp - 408"		09262	Number 62:	.38 Colt Super Automatic
7.7mm x 58 Japanese Arisaka	.45-70 U.S. Government		09263	Number 63:	
8mm x 57 Mauser (8mm Mauser)	.45-90-2.4" Sharps Straight		09264	Number 64:	.480 Ruger
8mm-06	.45-100-2.6" Sharps Straight		09265	Number 65:	99241
.338 Federal	.45-110-2 7/8" Sharps Straight		09266	Number 66:	Number 41:
.338-06	.45-120-3 1/4" Sharps Straight		09267	Number 67:	.404 Jeffery
.35 Whelen	.460 Weatherby Magnum		09268	Number 68:	99242
.358 Winchester	09215	Number 15:	09269	Number 69:	Number 42:
9.3mm x 62 Mauser	6.5mm x 50 Japanese Arisaka		09270	Number 70:	.376 Steyr
.400 CorBon	09216	Number 16:	09271	Number 71:	
.45 Automatic (.45 ACP)	.30 Luger (7.65mm Luger)		09272	Number 72:	.223 Winchester Super Short Magnum
.45 Glock Action Pistol	.30 Mauser (7.63 Mauser)		09273	Number 73:	.243 Winchester Super Short Magnum
09204	Number 4:	.356 TSW	09274	Number 74:	.25 Winchester Super Short Magnum
.257 Weatherby Magnum	9mm FAR		09275	Number 75:	.270 Winchester Short Magnum
.264 Winchester Magnum **	9mm Luger		09276	Number 76:	7mm Winchester Short Magnum
6.5 Remington Mag	9mm Makarov		09277	Number 77:	
.270 Weatherby Magnum	9mm x 21		09278	Number 78:	.325 Winchester Short Magnum
7mm Remington Magnum **	9mm x 23 Winchester		09279	Number 79:	99244
7mm Shooting Times Westerner	09217	Number 17:	09280	Number 80:	Number 44:
7mm Weatherby Magnum	.30 M1 Carbine		09281	Number 81:	.500 Smith & Wesson
.30-338 Winchester Magnum	.32 Auto (7.65mm Automatic)				
.300 Holland & Holland Magnum	09218	Number 18:			
.300 Weatherby Magnum	.44 Magnum				
.300 Winchester Magnum **	.44 Special				
.308 Norma Magnum	09219	Number 19:			
8mm Remington Magnum	.30 Remington				
.338 Winchester Magnum	6.8 Remington SPC				
.340 Weatherby Magnum	09220	Number 20:			
.350 Remington Magnum	.45 Colt				
9.3mm x 74 Rimmed	.454 Casull				

* Shoulder angle of improved version.

** Some Browning, DWM, Lapua, Norma, RWS and SAKO cases require an RCBS #26 Shell Holder.

*** If cartridge is not listed, consult the RCBS Special Order Catalog for appropriate shell holder.

Extended Shell Holders \$10.95

Part #	#
08952	2
08953	3
08956	6

Part #	#
08960	10
08968	18

5-Station Shell Plates

For Pro 2000, AmmoMaster Auto, Piggyback, Piggyback II and Piggyback-3 / 4 Progressive Presses \$33.95

See Reference Chart on page 30

Plate Size	Part #	Plate Size	Part #
Number 1	88801	Number	Number
23 88823		Number 24	88824
Number 2	88802	Number 25	88825
Number 3	88803	Number 26	88826
Number 4	88804	Number 27	88827
Number 5	88805	Number 28	88828
Number 6	88806	Number 29	88829
Number 7	88807	Number 30	88830
Number 8	88808	Number 31	88831
Number 9	88809	Number 32	88832
Number 10	88810	Number 33	88833
Number 11	88811	Number 34	88834
Number 12	88812	Number 35	88835
Number 13	88813	Number 36	88836
Number 14	88814	Number 37	88837
Number 15	88815	Number 38	88838
Number 16	88816	Number 39	88839
Number 17	88817	Number 40	88840
Number 18	88818	Number 41	88841
Number 19	88819	Number 42	88842
Number 20	88820	Number 43	88843
Number 21	88821	Number 44	88844

Note: The Piggyback, Piggyback II and Piggyback-3 Progressive Presses are restricted to an overall cartridge length of 2.260". Check cartridge length before ordering Shell Plates.

Auto 4x4 Shell Plates

For Auto 4x4 and 4x4 Presses \$36.95

See Reference Chart on page 30

Plate Size	Part #	Plate Size	Part #
Number1	87601	Number 18	87618
Number2	87602	Number 19	87619
Number3	87603	Number 20	87620
Number4	87604	Number 21	87621
Number6	87606	Number 23	87623
Number7	87607	Number 24	87624
Number9	87609	Number 25	87625
Number10	87610	Number 26	87626
Number11	87611	Number 27	87627
Number12	87612	Number 28	87628
Number15	87615	Number 30	87630
Number16	87616	Number 32	87632
Number 17	87617		

Shell Holders, Extended Shell Holders & Shell Holder Rams

If your shell holders don't securely grip the shell and firmly fit into the press during reloading, you're bound to have headspace and sizing problems. At RCBS we manufacture our shell holders to the industry's tightest tolerances, using only the finest steel.

Shell Holder Rams and Adapters permit the use of RCBS Shell Holders on the presses indicated. Clip spring holds Shell Holder in place, yet allows rotation to any convenient angle.

Shell Holder (See Chart)	\$6.95
Extended Shell Holder (See Chart)	\$10.95
09109 Shell Holder Ram, "C", RS, JR	\$25.95
09180 Shell Holder Adapter, "H"	\$16.95
99200 Shell Holder Adapter, Herters	\$19.95



Stuck Case Remover

Our Stuck Case Remover extracts stuck cases from standard sizer dies without damaging the die, using a very simple two-step removal process.

09340 Stuck Case Remover \$17.95



Stuck Case Remover-2 Kit

The Stuck Case Remover-2 Kit lets you extract cases from dies with removable guide bushings. It's also useful for our Competition Dies or other sizer dies with a raised expander ball. Kit contains two extractor nuts and two punch rods.

09355 Stuck Case Remover-2 Kit \$7.95



Fold-Up Hex Key Wrench

Eight heat-treated hex keys fit most hex head screws on RCBS equipment. Key sizes: .050", 1/16", 5/64", 3/32", 7/64", 1/8", 9/64" and 5/32". Handy and easy to locate on the bench when you need a hex key.

98975 Fold-Up Hex Key Wrench \$7.95



Trigger Pull Gauge

Lets you measure the trigger pull force of any firearm. Reads grams on the left, ounces on the right. Capacity 2000 grams; 72 ounces.

09450 Trigger Pull Gauge \$22.95

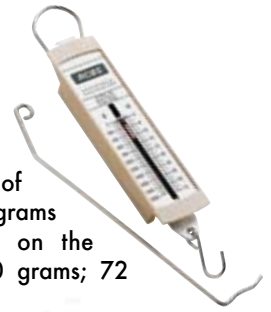

Premium Trigger Pull Scale

Measure the force needed for trigger release of firearms. Scale is accurate to ±2 ounces in 2 ounce increments up to 8 pounds. A sliding indicator remains at the highest reading when the trigger releases, allowing accurate measurement.

87307 Premium Trigger Pull Scale \$36.95



Equipment readily secures to plate for quick tool changeovers. Makes the most of limited bench space

Accessory Base Plate-2

Save time, space and eliminate a loading bench top full of holes. Simply attach the Base Plate-2 to any work surface, then use the pre-tapped, letter-coded holes to quickly mount or dismount RCBS Case Trimmers, Trim Pro, Powder Measure Stand, Lube-A-Matic-2, Reloader Special, Rock Chucker, Pro 2000, Turret Press, AmmoMaster, Partner Press and the APS Bench Mounted, Automatic and Standard Priming Tools. Fastening hardware included. Measures approximately 10" x 6" x 1".

09280 Accessory Base Plate-2 \$30.95



A durable and convenient way to carry your handloads. Available in several sizes to sure-fit the cartridge size

Ammo Boxes

These tough, plastic boxes have flush exteriors with recessed latches. They're designed to stack easily, and feature an anti-rattle bullet-tip nest, empty case support, and long-lasting hinge. Available in five sizes:

Ammo Boxes:	
86901	Small Rifle \$5.95
86902	Medium Rifle \$5.95
86903	Large Rifle \$7.95
86905	Medium Pistol \$4.95
86906	Large Pistol \$5.95

See Reference Chart on page 30

Military Trigger Pull Scale

Measure the force needed for trigger release of your Double Action pistol or Military Rifle, you might be surprised! Scale is accurate to ±8 ozs in 8 oz increments. Measures in pounds or kilograms from 0-25 pounds or 0-11.34 kilograms. A sliding indicator remains at the highest level. Anodized aluminum body with stainless steel spring.

87306 Military Trigger Pull Scale \$41.95



Tru-Weight Bow Scale

Measure the pull weight of your bow. Scale is accurate to ±1 pound. Measures in pounds or kilograms. 15-90 pounds or 6.8-40.8 kilograms of pull. A sliding indicator remains at the highest level.

87308 Tru-Weight Bow Scale \$41.95



Pro-Melt™ Furnace

Here's a hot little number. Our heavy-duty Pro-Melt furnace has a high-temperature heating element, plus an industrial-grade thermostat coupled to a remote sensor on the bottom of the pot for added accuracy and response. Range: 650° to 850° F. Can be set up for either left or right-handed operation. Lead capacity is 22 pounds. 800 Watts.

Pro-Melt Furnace:		
81100	120 VAC	\$387.95
81200	240 VAC (EUR)	\$399.95



Lead Pot

1 This heavy-duty cast-iron pot holds up to 10 pounds of molten metal. It features a flat bottom for stability, bail handle, pouring spout, and a tab lifter for gripping with insulated tongs or pliers.

80010	Lead Pot	\$18.95
-------	----------	---------

Lead Thermometer

With a 1000° F range and ±1% accuracy, our lead thermometer lets you pour lead at the optimum temperature. Large numbers are printed on a 1-1/2", glass-covered face. Six inch probe works with RCBS Pro-Melt furnace or pot. An adjustable 6" handle helps to prevent burning of fingers.

81175	Lead Thermometer	\$49.95
-------	------------------	---------

Lead Dipper

A large-capacity bowl for easy scooping and stirring. The lead dipper has a tapered pouring spout to fit sprue holes and has a solid hardwood grip. Overall length: 11-1/2 in.

80015	Lead Dipper	\$21.95
-------	-------------	---------

Ingot Mould

2 Mould up to four ingots at once and cool them quickly with this handy accessory. It's perfect for melting down scrap lead and preparing alloys for future use.

80005	Ingot Mould	\$18.95
-------	-------------	---------



WARNING:

Melting lead and casting lead objects will expose you and others in the area to lead, which is known to cause birth defects, other reproductive harm and cancer. See instructions on Reducing Exposure supplied with product.



Bullet Mould Handles

Solid steel frames with extra-long, premium hardwood handles for comfort. Perfect for home bullet casting. One size fits all RCBS bullet moulds only.

80025 Bullet Mould Handles \$36.95

Looking for unbeatable accuracy?
RCBS built the mould.

Mould Mallet

Be kind to your bullet moulds. Stop using a metal object to tap out your cast lead bullets and potentially damaging your mould! RCBS has reintroduced our wooden mould mallet to safely accomplish this goal.

80007 Mould Mallet \$10.95



Neck Expander Dies for Cast Rifle Bullets

To eliminate deforming the base and shaving lead off the sides of your lead rifle bullets during seating. RCBS strongly recommends using our Neck Expander Die. In one step, the neck expander die expands the neck and slightly flares the case mouth of your bottle neck cases.



39800 Neck Expander Body \$19.95
39801 Neck Expander Plug Rod \$4.95
Neck Expander Plug (see chart below) \$9.95

Neck Expander Dies

Bullet Diameter	Complete Die \$25.95	Expander Plug Only \$9.95
.224"	39803	39851
.228"	39805	39853
.243"	39807	39855
.257"	39809	39857
.264"	39811	39859
.277"	39813	39861
.284"	39815	39863
.308"	39817	39865
.309"	39819	39867
.310"	39821	39869
.311"	39823	39871
.321"	39825	39873
.323"	39827	39875
.338"	39829	39877
.348"	39830	39878
.358"	39831	39879
.375"	39833	39881
.416"	39835	39883

Lube-A-Matic-2 Bullet Sizer/Lubricator

Size and lubricate cast bullets in one step with the Lube-A-Matic-2. Just insert a bullet in the sizer die and pull the handle. A sized and lubricated bullet ejects on the upstroke. A fingertip regulator lets you fine-tune lubricant flow. The Lube-A-Matic-2 also seats gas checks. A high quality tool that's a "must-have" item for the serious bullet caster.



80040 Lube-A-Matic-2 \$177.95
86880 Dust Cover \$9.95

(Die and top punch sold separately.) See chart on page 44 and 45 for sizer die and top-punch sizes

Bullet Lubricant

RCBS Bullet Lubricant fits the Lube-A-Matic Sizer/Lubricator and most others that use a hollow stick lubricant. It's a non-toxic, temperature resistant blend, developed in cooperation with top-rated competition cast-bullet shooters. Our rifle bullet lubricant is a blend of Alox and beeswax, formulated to NRA specifications. Works fine for pistol bullets. Rifle Lube for outdoor use only.

80008 Bullet Lubricant \$4.95
80009 Rifle Bullet Lubricant \$4.95



Bullet Casting Video

An age-old art explained with modern technology. This comprehensive video is authoritative, informative, and entertaining to watch. Step-by-step instructions on cast bullet preparation and moulding.

99907 Bullet Casting Video (Not Pictured) \$20.95

BULLET CASTING

Alternate Bullet Sizes for Cast Bullets

Caliber	Size	Sizer Die	Part No.
.22	.224"	.224" dia.	82200
6mm	.243"	.243" dia.	82201
.25	.257"	.257" dia.	82203
270	.277"	.277" dia.	82205
7mm	.284"	.284" dia.	82208
.30	.308"	.308" dia.	82211
.30	.310"	.310" dia.	82213
.30	.311"	.311" dia.	82214
.32	.312"	.312" dia.	82242
.32	.313"	.313" dia.	82215
.32	.314"	.314" dia.	82216
38/357	.354"	.354" dia.	82219
38/357	.355"	.355" dia.	82220
.38	.356"	.356" dia.	82221
357	.357"	.357" dia.	82222
375/38-55	.375"	.375" dia.	82224
.40	.408"	.408" dia.	82249
44-40	.427"	.427" dia.	82227
.44	.429"	.429" dia.	82228
.44	.431"	.431" dia.	82230
.45	.450"	.450" dia.	82231
.45	.451"	.451" dia.	82232
45 Colt	.452"	.452" dia.	82233
.45	.457"	.457" dia.	82235
500 S&W/50 AE	.501"	.501" dia.	82250

Silhouette Bullet Moulds \$73.95



Caliber	6.5	7mm	308	308	357	44
Size	.265	.285"	.309"	.309"	.358"	.430"
Mould	6.5-140 SIL	7mm-145-SIL	308-165-SIL	308-200-SIL	357-180-SIL	429-240-SIL
Part Number	82149	82150	82152	82153	82154	82156
Sizer Die	.265" dia.	.285" dia.	.309" dia.	.309" dia.	.358" dia.	.430" dia.
Part Number	82207	82209	82212	82212	82223	82229
Top Punch	#520	#531	#541	#541	#430	#422
Part Number	85520	85531	85541	85541	82530	82526
Seater Plug		7mm SIL	308 SIL	308 SIL	357 SIL	44 SIL
Part Number		09696	09697	09697	90019*	90031*

Older die sets utilizing a 1/4 - 28 threaded seater plug require #09698 for .357 SIL and #09699 for .44SIL.

Minie Ball Moulds \$81.95



Diameter	.575"
Mould	#58-500-M+
Part #	82103

Abbreviation Guide

- CSA - C Sharps Arms
- TG - Target
- SPL - Special
- U - Universal
- PT - Pointed
- CAV - Cavalry
- CN - Conical Nose
- SAA - Single Action Army
- FN - Flat Nose
- RN - Round Nose
- SWC - Semi-Wadcutter
- WC - Wadcutter
- SP - Semi-Point
- BB - Bevel Base
- M - Minie Ball
- R - Round Ball
- SIL - Silhouette
- K - Keith Type
- BPS - Black Powder Silhouette
- CM - Cowboy Mould
- U - Universal

All RCBS Bullet Moulds are machined to exacting specifications ensuring accurate and clean casts time after time.

NOTE: All moulds are shown slightly smaller than actual size. Unless noted otherwise, all RCBS bullet moulds are double cavity type. Each mould is identified by a five or six digit number, followed by two or three letters. The first two or three digits identify bullet caliber, the last three are bullet weight in grains. (Round Balls are identified by caliber only.) Bullet weights are established by the following methods: Rifle & Silhouette Bullets—Linotype alloy. • Pistol, Black Powder Silhouette and C Sharps Arms Bullets—An alloy of one part tin to ten parts lead. • Round & Minie Balls—Pure lead. + Available in single cavity only. * Used to lube bullet only bullet casts .408" to .409".

Rifle Bullet Moulds \$73.95

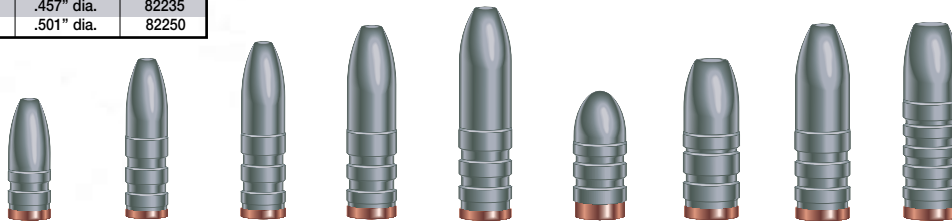

Caliber	22	6mm	25	270	7mm	30	30	30	30
Size	.225"	.244"	.258"	.278"	.285"	.309"	.309"	.309"	.309"
Mould	22-055-SP	243-095-SP	257-120-SP	270-150-SP	7mm-168-SP	30-115-SP	30-150-FN	30-180-SP	30-180-FN
Part Number	82007	82015	82016	82017	82018	82009	82019	82020	82014
Sizer Die	.225" dia.	.244" dia.	.258" dia.	.278" dia.	.285" dia.	.309" dia.	.309" dia.	.309" dia.	.309" dia.
Part Number	82240	82202	82204	82206	82209	82212	82212	82212	82212
Top Punch	#506	#509	#515	#529	#531	#535	#546	#541	#546
Part Number	85506	85509	85515	85529	85531	85535	85546	85541	85546

Rifle Bullet Moulds \$73.95



Caliber	7.62mm	310 Cadet	32	35	375, 38-55	.38-55	40	40	40
Size	.309"	.323"-.310"	.321"	.358"	.376"	.378"	.410"	.410"	.410"
Mould	7.62-130-SPL	310-120-FN	32-170-FN	35-200-FN	37-250-FN	378-312-BPS	40-300-SP-CSA	40-350-SP-CSA+	40-400-SP-CSA+
Part Number	82022	82023	82024	82028	82029	82090	82070	82072	82074
Sizer Die	.309" dia.	Bullet	.321" dia.	.358" dia.	.376" dia.	.378" dia.	.410" dia.*	.410" dia.*	.410" dia.*
Part Number	82212	NOT SIZED	82217	82223	82225	82252	82226	82226	82226
Top Punch	#554	or	#550	#565	#570	#608	#378	#378	#378
Part Number	85554	Lubed	85550	85565	85570	85608	82520	82520	82520

Rifle Bullet Moulds \$73.95

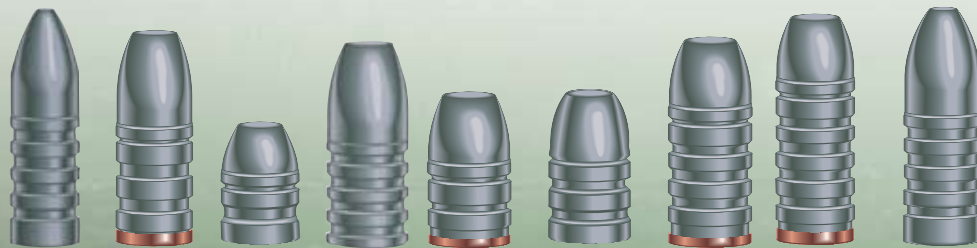

Caliber	40	416	44-40	11mm	45	45	45	45	45
Size	.408"-.409"	.417"	.428"	.446"	.458"	.458"	.458"	.458"	.458"
Mould	40-400-BPS+	416-350-FN+	44-200-FN	44-370-FN	45-300-FN	45-325-FN-U	45-405-FN+	45-500-FN+	45-500-BPS+
Part Number	82086	82075	82036	82093	82051	82045	82053	82054	82085
Sizer Die	.410" dia.*	.417" dia.	.428" dia.	.446" dia.	.458" dia.	.458" dia.	.458" dia.	.458" dia.	.458" dia.
Part Number	82226	82246	82244	82253	82236	82236	82236	82236	82236
Top Punch	#609	#562	#595	#585	#600	#383	#600	#600	#607
Part Number	85609	85562	85595	85585	85600	85583	85600	85600	85607



WARNING:
Melting lead and casting lead objects will expose you and others in the area to lead, which is known to cause birth defects, other reproductive harm and cancer. See instructions on Reducing Exposure supplied with product.

Cowboy Bullet Moulds

RCBS Cowboy Moulds are double cavity type and are designed for use with RCBS Bullet Mould Handles. Each mould is identified by a four or five digit number, followed by the letters CM for Cowboy Mould. The first two digits identify bullet caliber, the last two or three are bullet weight in grains. Bullet weights are established by using an alloy of one part tin to twenty parts lead.

Round Ball Moulds \$70.95



Diameter	Mould	Part Number
.435"	.435-112	82134
.440"	.440-116	82135
.451"	.451-125	82138
.457"	.457-130	82140
.490"	.490-160	82142

North-South Skirmish Bullet Moulds (Adjustable) \$89.95

Diameter	Mould	Part Number
.500"	.500 Hodgdon+	82166
.520"	.520 Hodgdon+	82170
.540"	.540 Hodgdon+	82172



North-South Skirmish Bullet Moulds \$89.95

Diameter	Mould	Part Number
.576"	576-412 Hodgdon+	82160
.578"	578-414 Hodgdon+	82161
.580"	580-416 Hodgdon+	82162
.584"	584-419 Hodgdon+	82163



Cowboy Bullet Moulds \$73.95



Cowboy Bullet Moulds \$70.95

Lube-A-Matic Sizer Die & Top Punch

Lube-A-Matic Sizer Die \$24.95
Lube-A-Matic Top Punch \$8.95
Silhouette Bullet Seater Plug \$4.95

Caliber	.25-20 Win.	.30-30 Win.	Caliber	32 H & R Mag/ .32-20 Win.	.38 Spec/ .357 Mag.	.38 Spec/ .357 Mag.	.38-40 WCF	.44-40 WCF/ .44 Russ/ .44 Spec/ .44 Mag.	.45 S&W Sch/ .45 Long Colt
Size	.258"	.309"	Size	.314"	.358"	.358"	.401"	.428"- .430"	.452"- .454"
Mould	25-85-CM	30-150-CM	Mould	32-90-CM	38-140-CM	38-158-CM	40-180-CM	44-200-CM	45-230-CM
Part #	82301	82302	Part #	82303	82304	82305	82306	82307	82308
Sizer Die	.258"	.309"	Sizer Die	.314"	.358"	.358"	.401"	.428"/.430"	.452"/.454"
Part Number	82204	82212	Part Number	82216	82223	82223	82245	82244/82229	82233/82234
Top Punch	#630	#631	Top Punch	#632	#633	#633	#635	#636	#637
Part #	85630	85631	Part #	85632	85633	85633	85635	85636	85637

Pistol Bullet Moulds \$70.95

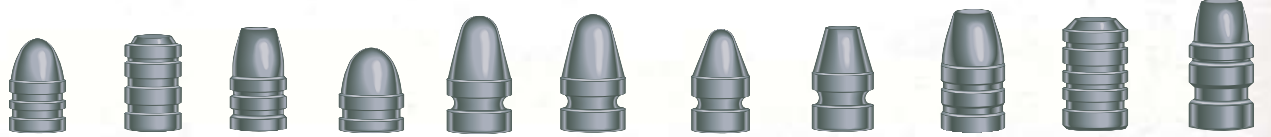

Caliber	32	32	32	38	9mm	9mm	9mm	9mm	9mm	9mm	38/357	38/357
Size	.311"	.314"	.314"	.356"	.356"	.356"	.356"	.356"	.356"	.356"	.358"	.358"
Mould	32-077-RN	32-098-WC	32-098-SWC	38-090-RN	09-115-RN	9mm-124-RN	09-124-RN-TG	09-124-CN	9mm-147-FN	38-148-WC	38-150-WC	
Part Number	82021	82060	82061	82057	82026	82062	82063	82027	82077	82031	82032	
Sizer Die	.311" dia.	.314" dia.	.314" dia.	.356" dia.	.356" dia.	.356" dia.	.356" dia.	.356" dia.	.356" dia.	.358" dia.	.358" dia.	
Part Number	82214	82216	82216	82221	82221	82221	82221	82221	82221	82223	82223	
Top Punch	465	#445	#444	#311	#115	#401	#115	#402	#556	#429	#429	
Part Number	82536	82543	82542	82513	82504	82521	82504	82522	85556	82529	82529	

Pistol Bullet Moulds \$70.95

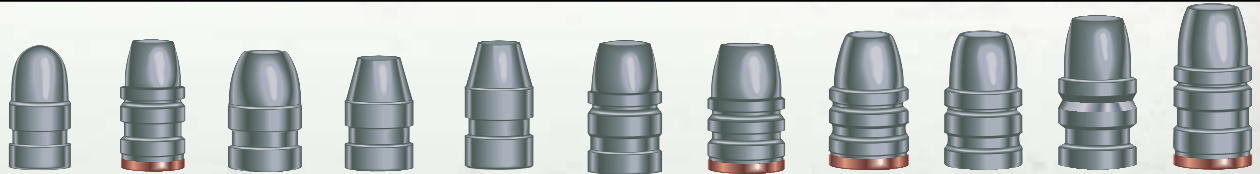

Caliber	38/357	38/357	40/10mm	10mm	10mm	41	44	44	44	44	44
Size	.358"	.358"	.401"	.400"	.400"	.410"	.430"	.430"	.430"	.430"	.430"
Mould	38-158-RN	38-158-SWC	40-180-FN	10mm-170-SWC	10mm-200-SWC	41-210-SWC	44-225-SWC	44-240-SWC	44-245-SWC	44-250-K	44-300-SWC
Part Number	82064	82065	82066	82067	82068	82039	82041	82042	82043	82080	82079
Sizer Die	.358" dia.	.358" dia.	.401" dia.	.400" dia.	.400" dia.	.410" dia.	.430" dia.	.430" dia.	.430" dia.	.430" dia.	.430" dia.
Part Number	82223	82223	82245	82243	82243	82226	82229	82229	82229	82229	82229
Top Punch	#311	#429	#558	#518	#518	#420	#421	#421	#421	#421	#421
Part Number	82513	82529	85558	85518	85518	82541	82527	82527	82527	82527	82527

Pistol Bullet Moulds \$70.95

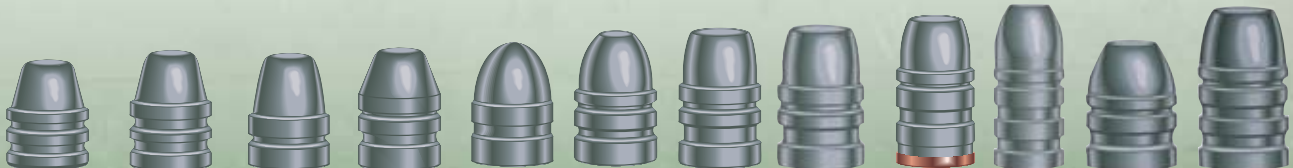

Caliber	45 Auto	45 Auto	45 Auto	45	45 Auto	45 Colt	45 Colt	45 Colt	45	480 Ruger*	50 AE	500 S&W
Size	.452"	.452"	.452"	.454"	.452"	.454"	.454"	.454"	.452"	.476"	.500"	.500"
Mould	45-185-SWC-BB	45-200-SWC	45-201-SWC	45-225-CAV	45-230-RN	45-250-FN	45-255-SWC	45-270-SAA	45-300-SWC	476-400-SWC+	50-340-SWC+	50-400-SWC+
Part Number	82052	82046	82047	82081	82048	82049	82050	82092	82083	82094	82087	82099
Sizer Die	.452" dia.	.452" dia.	.452" dia.	.454" dia.	.452" dia.	.454" dia.	.454" dia.	.454" dia.	.452" dia.	.476" dia.	.500" dia.	.500" dia.
Part #	82233	82233	82233	82234	82233	82234	82234	82234	82233	82237	82254	82254
Top Punch	#680	#460	#680	#552	#374	#190	#424	#424	#424	#638	#611	#639
Part Number	82545	82534	82545	85552	82519	82506	82528	82528	82528	85638	85611	85639

* also .475 Linebaugh
+ single cavity mould





RCBS.LOAD™

Comprehensive Software for The Serious Shooter

Traditionally, ballistics software has fallen into two categories, programs that analyze trajectories, and programs that let you archive reloading data that you developed. If you wanted to do both, you had to purchase two programs. If you wanted industry reloading data in electronic form, you were out of luck. Until now — Now there's RCBS.LOAD, a sophisticated program that combines the latest technology in trajectory analysis with an incredible database manager. Bullet trajectories up to six at a time can be viewed as a graph, and you can choose from a list of 1,930 component bullets plus a catalog of over 1,762 factory loads. You can prescribe the initial firing conditions, change the environmental conditions and readily determine maximum point-blank range in three dimensions.

As a database manager, RCBS.LOAD sets new standards. Data can be viewed as text and also graphed for visual analysis. Data can be sorted and filtered to see specific details. Included is an index of data sources showing where to find loads for over 760 standard and wildcat cartridges. RCBS.LOAD version 3.0 includes electronic versions† of the Speer Reloading Manual #13, the



RCBS.LOAD is a great addition to the reloading bench. Now you can accurately test load performance before actually firing a shot

Program is easily installed from a CD ROM onto your computer system. Requires a Windows environment to function

RCBS Cast Bullet Manual and has been upgraded to access all but the most current reloading manuals from other industry sources free of charge! With access to 30,000 plus loads, the collection of data now included with RCBS.LOAD is typically more data than one might compile over a lifetime. Additional electronic manuals†** covering the most recent industry reloading sources can be purchased from RCBS. With RCBS.LOAD, you build your own reloading databases that can be analyzed like the industry sources.

RCBS.LOAD comes with an exciting Cartridge Designer feature. Starting with a parent cartridge, you can change the dimensions and see the case capacity for your wildcat cartridge recalculate automatically. There's a handy Ballistic Coefficient Calculator in case your bullet isn't in the massive bullet database. Other useful references include a kinetic energy calculator, minimum twist rate chart, pressure assignments list, metric equivalents, powder burning rate chart, and a database of dimensioned drawings for over 496 cartridges.

Best of all, this power comes at about the cost of four boxes of 30-30 ammo. Try RCBS.LOAD and see why it's the standard by which all other ballistic programs will be judged.

99915 RCBS.LOAD Reloading Software \$107.95

‡ Electronic versions of manuals contain all reloading data, excluding text or pictures
 * Windows 98 and Windows NT are registered trademarks of Microsoft, Inc.
 ** Actual reloading manual necessary to unlock data.

RCBS.LOAD FEATURES & BENEFITS

GRAPH DATA TOOL

- Provides a graph of muzzle velocity vs. powder weight (other variables can be selected)
- Filters can be selected to find specific data
- Data comparing cartridges can be displayed on the same screen
- Data can be sorted into different panes according to variables such as bullet weight, bullet type and powder

EXTERNAL BALLISTICS CALCULATOR

- Performs real trajectory calculations based on the actual equations of motion
- G1 Drag model is used for all computations
- Provides bullet trajectory information relative to the line of sight along the range
- Includes an axial view at the impact point with a graduated scale

CARTRIDGE DRAWING UTILITY

- Database of some 496 different cartridges
- Technical drawings for information on diameter, length and angles

SYSTEM/HARDWARE MINIMUM REQUIREMENTS:

- Operating System: Windows 95®, Windows 98® or Windows NT® (v3.51 or higher)*
- Processor: 486DX 100Mhz
Memory: 16MB RAM
- Hard Drive Space: 8MB (up to 15MB if all optional libraries are purchased and installed)
- Display: Color monitor capable of 800 x 600 pixel resolution; 1024 x 768 recommended, 1280 x 1024 pixel resolution highly recommended



SPEER Reloading Manual #13

The original bible of reloading, and still the number one reference worldwide. More than 700 pages of how-to information, with charts, illustrations and photographs. Over 9,000 powder loads, plus bullet data, detailed ballistics tables, bullet energy and velocity tables, special techniques sections, problem solving section and much more. An indispensable tool for every reloader's bench.

709511 Speer Reloading Manual #13 \$20.95



Precisioneered® Handloading Video

Whether you're an old pro or just getting started in handloading, this is the best 30-minute time investment you'll ever make. Precisioneered Handloading is both entertaining and educational — a must see for the do-it-yourselfer.

99911 Precisioneered Handloading Video \$19.95



RCBS Black Logo Hat

Superior brushed cotton twill sandwich visor low profile pro style cap. 6-panel with embroidered eyelets. Velcro closure.

99148 Black Logo Hat \$9.95



RCBS Tan/Green Logo Hat

Superior brushed cotton twill sandwich visor low profile pro style cap. 6-panel with embroidered eyelets. Velcro closure.

99149 Tan/Green Logo Hat \$9.95



Hearing Protectors

Repeated exposure to gunfire can contribute to hearing loss. The RCBS Hearing Protectors are a convenient way to preserve your hearing.

With a 29-decibel noise reduction rating, our hearing protectors are the most effective you can buy – and the most comfortable. Cushions are filled with liquid for form fit and the padded headband is fully adjustable to head size.

99165 Hearing Protectors \$34.95

Generous padding in the adjustable headband makes for a comfortable fit at the range or on the clays course



RCBS Forest Green Polo

100% cotton jersey fabric. Contoured collar and cuffs, double stitched seams. Clean finished placket with reinforced box and 3 woodtone buttons. Quarter-turned to eliminate center crease. Roomier European cut for better comfort.

Available in M, L, XL and XXL

99144	Medium Forest Green Polo	\$22.95
99145	Large Forest Green Polo	\$22.95
99146	XL Forest Green Polo	\$22.95
99147	XXL Forest Green Polo	\$25.95

RCBS
605 Oro Dam Blvd.
Oroville, CA 95965-5792

PRST. STD
U.S. POSTAGE
PAID
PERMIT 116
OROVILLE, CA

ATK AMMUNITION AND RELATED PRODUCTS

A unique collection of brands that gives shooting and outdoor enthusiasts everything they need in one place. From ammunition and reloading equipment to gun cleaning chemicals and accessories,

ATK Ammunition and Related Products offers advanced, high-performance products. Look for these leading suppliers under the ATK Ammunition and Related Products umbrella.



1.800.276.9337



1.800.533.5000 **RCBS**® WWW.RCBS.COM

These are trademarks of RCBS: Pro 2000, Powder Master, Range Master, Pow'r Puller, APS, AmmoMaster, CaseMaster, Trim Pro, Trim Mate, Powder Pro, Case Slick, Precision Mic, Pro-Melt, Reloader Special, Precisioneered, Ammo-Crafter, Lube-A-Matic, Uniflow, Rock Chucker, Rock Chucker Supreme, Green Machine, 4x4, Auto 4x4, Partner, Trim-Gauge, Little Dandy, Big Max, Positive Ram, Reloader Special-2, Reloader Special-3, Posi-Prime, Case Kicker, Sidewinder, Piggyback, Lube Die.

For customer service, please refer to the phone numbers listed above.